

Owner's Manual

EFX[®] 5.23

EFX[®] 5.33

Elliptical Fitness Crosstrainers



PRECOR[®] USA
move beyond[®]

Important Safety Instructions

When using an electrical appliance, always take basic precautions, including the following:

- Read all instructions before using the EFX[®]. These instructions are written to ensure your safety and to protect the unit.
- Before beginning any fitness program, see your physician for a complete physical examination.

Il est conseillé de subir un examen médical complet avant d'entreprendre tout programme d'exercice. Si vous avez des étourdissements ou des faiblesses, arrêtez les exercices immédiatement.

DANGER To reduce the risk of electrical shock always unplug the EFX from the electrical outlet immediately after using and before cleaning.

WARNING To reduce the risk of burns, fire, electric shock, or injury, take the following precautions:

- Do not allow children or those unfamiliar with its operation on or near the EFX. Do not leave children unsupervised around the unit.

- Never leave the EFX unattended when it is plugged in. Unplug the EFX from the power source when it is not in use, before cleaning it, and before putting on or taking off parts.
- Assemble and operate the EFX on a solid, level surface. Locate the EFX a few feet from walls or furniture.
- Maintain the EFX in good working condition. Refer to the *Maintenance* section. Make sure that all fasteners are secure.
- Use the EFX only for its intended purpose as described in this manual. Do not use accessory attachments that are not recommended by the manufacturer, as such attachments may cause injuries.
- Never operate the unit if it is damaged, not working properly, when it has been dropped, or has been dropped in water. Return the EFX to a service center for examination and repair.
- Keep the power cord and plug away from heated surfaces.
- Do not operate the EFX where aerosol (spray) products are being used or where oxygen is being administered.

- Do not use outdoors.
- Do not attempt to service the EFX yourself except to follow the maintenance instructions found in this manual.
- Never drop or insert objects into any opening. Keep hands away from moving parts.
- Keep all electrical components, such as the power cord and I/O switch, away from liquids to prevent shock. Do not set anything on the handrails, display console, or casing. Place liquids, magazines, and books in the appropriate receptacles.

DANGER The EFX must be connected to a properly grounded outlet. See ***Grounding Instructions***.

- Wear proper exercise clothing and shoes for your workout and avoid loose clothing. Do not wear shoes with heels or leather soles. Tie long hair back.
- Use care when getting on or off the EFX. Use the stationary handrail whenever possible.
- Keep your body and head facing forward. Never attempt to turn around on the EFX.
- Do not rock the unit. Do not stand on the handrail(s), display console, or casing.

- Never place your hands or feet in the path of the roller arm because injury may occur to you or damage may occur to the equipment.
- Do not overexert yourself or work to exhaustion. If you feel any pain or abnormal symptoms, stop your workout immediately and consult your physician.
- When the EFX is not in use, disconnect the unit by turning the power switch to the OFF (O) position, and then remove the power plug from the wall outlet.

Safety Approval

When identified with the ETL-c logo, the unit has been tested and conforms to the requirements of CAN/CSA-E-335-1/2-94, *Safety of Household and Similar Electrical Appliances*.

Grounding Instructions

The EFX must be grounded. If the unit malfunctions or breaks down, grounding provides a path of least resistance for electric current, which reduces the risk of electrical shock. The unit is equipped with a power cord having an equipment-grounding conductor and a grounding plug. The plug must be inserted into an outlet that is properly installed and grounded in accordance with all local codes and ordinances. Failure to properly ground the EFX could void the Precor Limited Warranty.

DANGER

Improper connection of the equipment-grounding conductor can result in a risk of electric shock. Check with a qualified electrician or service person if you are in doubt as to whether the unit is properly grounded. Do not modify the plug provided with the EFX. If it does not fit the outlet, get a proper outlet installed by a qualified electrician.

120 V Units Designated for U.S. Markets

The EFX uses a circuit with a nominal 120-volt rating. The unit's grounding plug looks like the plug shown in Diagram 1. The power outlet must have the same configuration as the plug. No adapter should be used with this product.

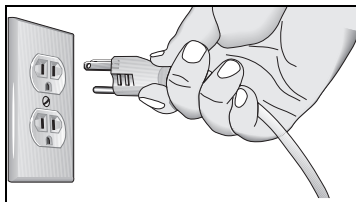

Diagram 1: 15 amp 120-volt plug

Radio Frequency Interference (RFI)

Federal Communications Commission, Part 15

The EFX has been tested and found to comply with

- the IEC EMC Directive (international electromagnetic compatibility certification)
- the limits for a Class B digital device, pursuant to Part 15 of the FCC Rules. These limits are designed to provide reasonable protection against harmful interference in a residential installation. The EFX generates, uses, and can radiate radio frequency energy and, if not installed and used in accordance with the owner's manual instructions, may cause harmful interference to radio communications.

If the EFX does cause harmful interference to radio or television reception, which can be determined by turning the unit OFF and ON, you are encouraged to try to correct the interference using one or more of the following measures:

- Reorient or relocate the receiving antenna for your TV, radio, VCR, etc.
- Increase separation between the unit and the receiver (TV, radio, etc.).

- Connect the EFX into a different power outlet on a dedicated circuit different from the one used by the receiver (TV, radio, etc.). No other appliance should be plugged into the same power outlet as the EFX.
- Consult an experienced radio/TV technician for help.

WARNING Per FCC rules, changes or modifications not expressly approved by Precor could void the user's authority to operate the equipment.

Canadian Department of Communications

This digital apparatus does not exceed the Class B limits for radio noise emissions from digital apparatus set out in the Radio Interference Regulations of the Canadian Department of Communications.

Le présent appareil numérique n'émet pas de bruits radioélectriques dépassant les limites applicables aux appareils numériques de la class B prescrites dans le Règlement sur le brouillage radioélectrique édicté par le ministère des Communications du Canada.

ATTENTION: Haute Tension

Débranchez avant de réparer

Obtaining Service

You should not attempt to service the EFX yourself, except for the maintenance tasks described in this manual. The EFX does not contain any user-serviceable parts. For information about product operation or service, see the Precor web site at www.precor.com.

Should you need more information regarding Customer Support numbers or a list of Precor authorized Service Centers, visit the Precor website at www.precor.com.

You will need the model and serial numbers whenever you contact Precor Customer Support. The serial number is printed on a label located on the rear cover (Diagram 2). For future reference, write the model and serial number and date of purchase in the space provided.

Model #: _____ Serial #: _____

Date purchased: _____

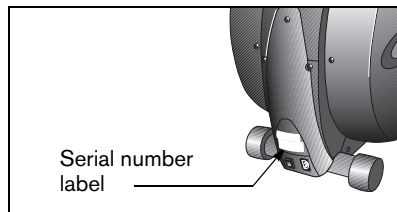

Diagram 2: Location of serial number

Table of Contents

Important Safety Instructions	1
Safety Approval	2
Grounding Instructions	3
Radio Frequency Interference (RFI)	4
Obtaining Service	5
EFX Safety Features	8
The Locking Pin	8
Using the Stationary Handrail	9
Turning the Unit ON and OFF	9
Heart Rate Features	10
Guidelines	10
Using SmartRate	11
Exercise to Your Target Heart Rate	12
Display Console	13
Scanning and the Display	15
CrossRamp® Display on the EFX5.23	16
Keypad	17
Changing the Display Features	
Using the SELECT Key	19

Workout Options	21
Choosing QUICKSTART	22
Selecting a User ID	23
Selecting a Program	24
Cooling Down After a Workout	25
Pausing During a Workout or the	
Cool-Down Period	26
Ending a Workout	26
Programs	27
Choosing a Program	27
Program Tips	29
Manual (MANL) Program	29
Crosstraining (XCTR) Program	30
Gluteal (GLUT) Program	31
Hill Climb (HILL) Program	31
Interval (INTn) Program	32
Random (RAND) Program	33
Weight Loss (WTLS) Program	33
Fitness Test (FITN)	34
Heart Rate Control (HRC) Program	38

Custom (CST1 or CST2) Programs39
 Calories (CAL) Program41
 Distance (DIST) Program41

**Advanced Programming
 and Troubleshooting42**

Advanced Programming Tips42
 Selecting a U.S. Standard or Metric Display43
 Informational Displays44
 Troubleshooting Error Codes47
 Troubleshooting Heart Rate47

Maintenance 48

Inspection 48
 Cleaning the Equipment 48
 Storing the Chest Strap 49
 Servicing the EFX 49
 Long-Term Storage 49

**Precor Residential Equipment
 Limited Warranty..... 50**

EFX Safety Features

The EFX is equipped with certain items that, when used properly, help sustain an enjoyable workout. These items include:

- Locking pin
- Stationary handrail
- I/O power switch

Important: Before exercising, review the Important Safety Instructions found at the beginning of this manual.

The Locking Pin

CAUTION: Injuries can occur from the roller arm movement. Always use the locking pin to secure the roller arm when the EFX is not in use.

The locking pin secures the roller arm to keep it from traveling up or down the ramp. Before beginning your workout, pull firmly on the pin to slide it out of the roller arm. Refer to Diagram 3. A lanyard attaches the locking pin to the ramp.

Store the locking pin underneath the ramp once it is removed from the roller arm. Refer to Diagram 4.

After exercising, use the locking pin to secure the roller arm.

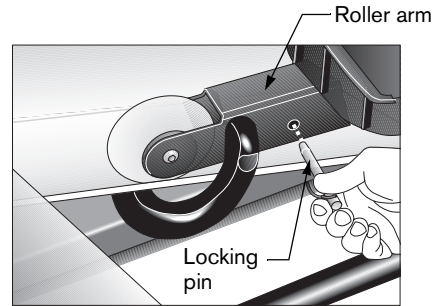

Diagram 3: Remove locking pin before exercising

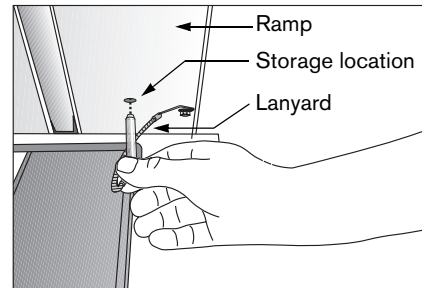

Diagram 4: Store the locking pin under the ramp

Using the Stationary Handrail

To maintain your balance, always grasp the stationary handrail when you step on or off of the foot pedals, and when you use the keypad.

Turning the Unit ON and OFF

To turn the unit ON and OFF, use the I/O power switch located at the rear of the unit, near the power cord receptacle. Refer to Diagram 5.

Important: *When it is not being used, turn the unit OFF.*

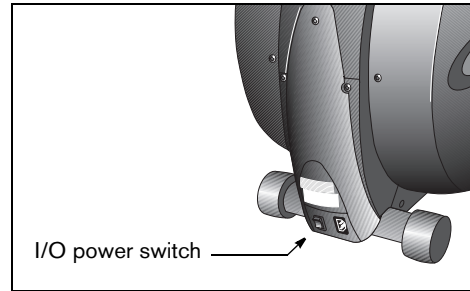
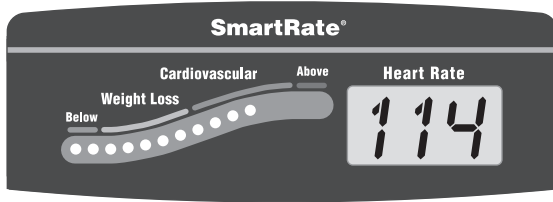

Diagram 5: I/O power switch

Heart Rate Features



Heart rate and SmartRate® features are available when the heart rate receiver is installed in the display console and you wear a chest strap. When a heart beat is detected, the heart rate display shows your heart rate and the SmartRate LED pulses and indicates your target zone.

Guidelines

Read the following before using the heart rate feature.

- Consult your physician before engaging in any vigorous exercise. Do not use the heart rate features until authorized by your physician.

- Know your heart rate (pulse) and your physician-recommended heart rate target zone. Individual heart rates vary according to several physiological factors and may not correspond directly with Diagram 6.

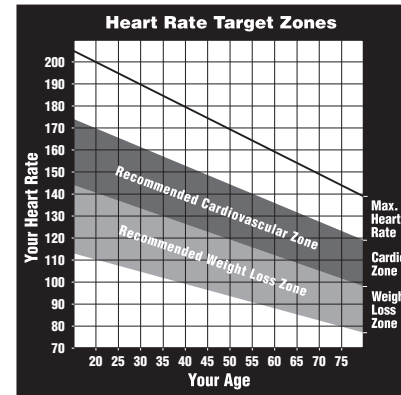

Diagram 6: Heart rate target zones

- The target heart rate is determined using a simple calculation:
(220 minus age) multiplied by 70%

- After you put on the chest strap, face the display console for a minimum of 15 seconds. This allows the receiver in the console to recognize the signal from the chest strap.
- Always face forward on the EFX and use the stationary handrail for balance.
- If three dashes (— — —) appear on the display, the EFX cannot detect a heart rate. Make sure the chest strap is positioned properly around your chest and against your skin.
- Maintain a constant stride rate while exercising. Find a comfortable stride rate between 100 and 150 strides per minute.

Using SmartRate

The SmartRate feature helps you monitor and maintain your heart rate in the target zone best suited to your specific needs. All 15 LEDs light during a workout. When you wear the chest strap, a single LED blinks and indicates the zone that your heart rate is in, either weight loss or cardiovascular.

The 15 LEDs in the SmartRate display are color-coded. A pulsating red LED indicates you are outside the recommended heart rate target zone. Yellow LEDs indicate when you are exercising within the weight loss zone. Green LEDs indicate when you are exercising within the cardiovascular zone.

Refer to Table 1 to see the relationship between the pulsating LED and your target heart rate.

The SmartRate indicator lights do not appear when:

- You press QUICKSTART at the banner.
- You bypass the AGE prompt.
- You do not wear or improperly position the chest strap.

Note: Review the information on the QUICKSTART card that accompanies your literature packet. It explains how to adjust the chest strap.

CAUTION: Your heart rate should never exceed 85% of your maximum aerobic heart rate. If it does, immediately reduce your strides per minute or, if possible, adjust the ramp incline to return your heart rate to your physician-recommended target zone.

Table 1. Heart rate target zones and SmartRate LEDs

Heart Rate Target Zone Percent	LED Lit	LED Blinking
Below 50	First	Red
50 to 54	Second	Red
55 to 57	Third	Yellow
58 to 60	Fourth	Yellow
61 to 63	Fifth	Yellow
64 to 66	Sixth	Yellow
67 to 69	Seventh	Yellow
70 to 71	Eighth	Green
72 to 74	Ninth	Green
75 to 76	Tenth	Green
77 to 79	Eleventh	Green
80 to 81	Twelfth	Green
82 to 84	Thirteenth	Green
85 to 87	Fourteenth	Red
Above 87	Fifteenth	Red

Exercise to Your Target Heart Rate

The EFX includes a program that lets you exercise based on a specified heart rate. You set your target heart rate at the beginning. As you exercise, the Heart Rate Program monitors your heart rate and automatically maintains it within a few beats per minutes (bpm) of your selected target. Your actual heart rate (pulse) appears in the Heart Rate display.

To use this program, select HRC. You must also wear the chest strap so the program can monitor your heart rate throughout the workout. For more information, refer to *Heart Rate Control (HRC) Program*.

Display Console

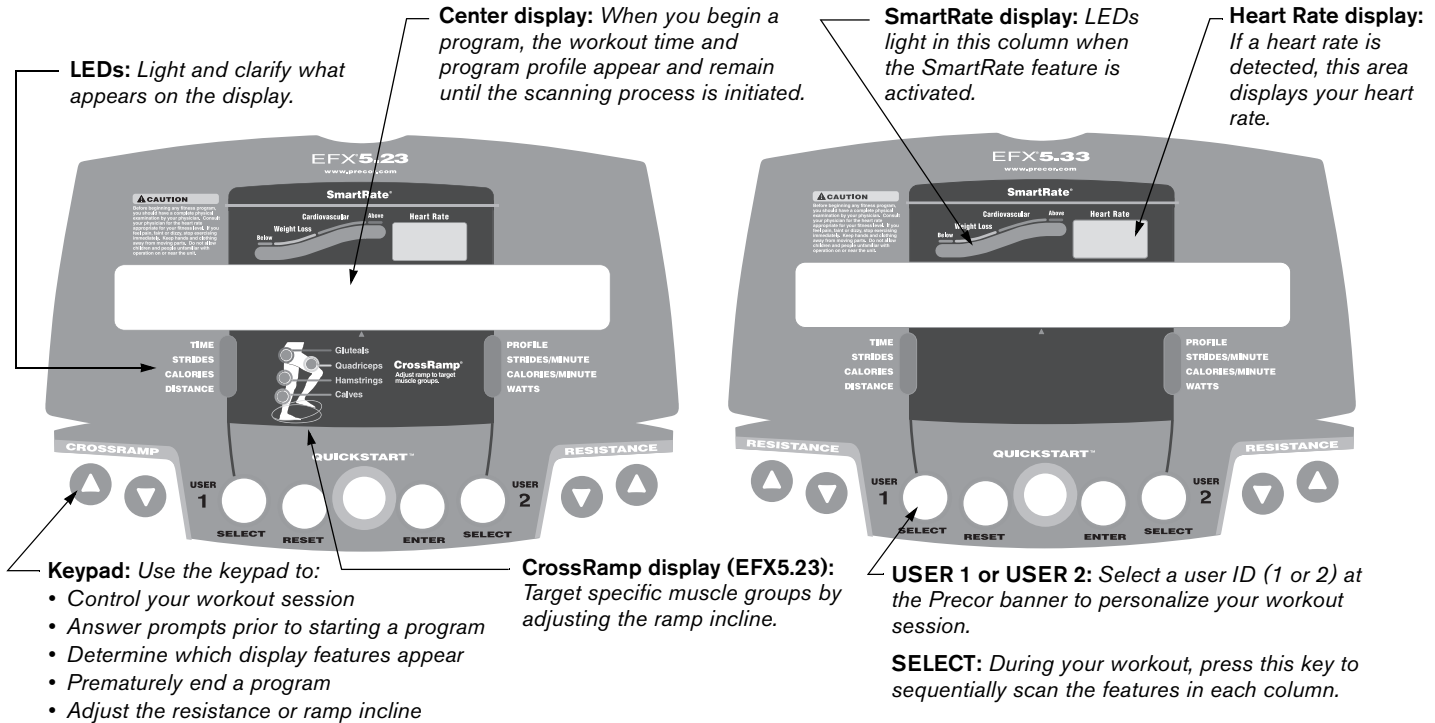

The following information describes the information that appears in the center display. The information is shown in alphabetic order.

CALORIES—displays the estimated cumulative number of calories burned. The calorie calculation is derived from the pedaling speed, resistance level, and your weight. An accurate weight entry results in a more accurate calorie count. When using QUICKSTART and a weight has not been specified, the default weight is 150 pounds (68 kilograms).

CALORIES/MINUTE—displays the approximate number of calories burned per minute.

DISTANCE—shows a linear distance in either miles or kilometers. The distance is calculated based on the amount of energy you expend during your workout, and is equal to a distance that you might run or walk using the same amount of energy.

PROFILE—appears on the display and corresponds to the program you selected. As you continue your workout, a blinking column indicates your position in the program.

- On the EFX5.23, the height of the column indicates the level of incline.
- On the EFX5.33, the height of the column indicates the level of resistance.

If the profile is only one cell high, then markers (•••••) appear occasionally and provide a sense of movement through the program.

STRIDES—shows the total number of strides completed, which is always an even number since two strides create one complete revolution of the flywheel. A stride is an exaggerated walking movement. On the EFX, if you start in a position with one foot pedal forward, a stride is completed when you move the rear foot pedal all the way forward while the other foot pedal moves to the rear.

STRIDES/MINUTE—displays your current pedaling speed (strides per minute) up to a maximum value of 510 strides per minute. When the strides per minute drops below 20, the EFX reverts to pause mode.

Important: *The display may not change as quickly as your stride. For example, when you stop suddenly from a high stride rate, the display does not immediately change to zero. Instead, it gradually decreases until it reaches zero.*

TIME—displays workout time in minutes and seconds; however, when you exceed 60 minutes during a single workout, the TIME display converts to hours and minutes. For programs with a workout time limit, the TIME display shows the amount of time remaining. For programs without a workout time limit, the TIME display indicates the amount of time you have been exercising.

USER 1 and USER 2—shows the current user selection after a user key has been pressed at the banner. For more information, refer to *Selecting a User ID*.

WATTS—displays the current mechanical energy generated by the unit.

Scanning and the Display



You can conduct scans of your workout statistics by pressing the SELECT key. Each SELECT key affects the column above it. Indicator lights appear next to the feature that is displayed. To select all eight features and activate the scanning mode, refer to *Changing the Display Features Using the SELECT Key*.

CrossRamp® Display on the EFX5.23

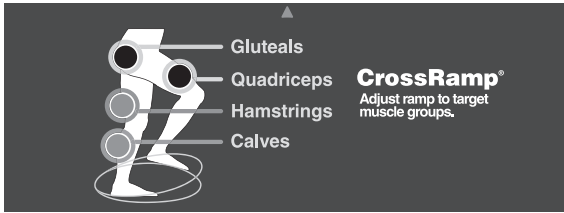

Diagram 7: Muscle groups affected by CrossRamp incline

On the EFX5.23, changes in ramp incline affect different muscle groups. As you raise and lower the incline, lights appear and indicate the muscle groups that are being worked. For example, Diagram 7 shows the Gluteals and Quadriceps indicator lights on when the ramp incline is set between 10 and 12.

To target a specific muscle group, adjust the ramp incline to the levels shown in the table below.

Table 2. Muscle groups targeted by CrossRamp settings

<i>Muscle Group</i>	<i>EFX5.23 Ramp Incline Settings</i>
Gluteal	1 through 20
Quadriceps	1 through 12
Hamstrings	1 through 9
Calves	1 through 6

For more information about workouts and the EFX5.23 CrossRamp feature, refer to the Precor web site (www.precor.com).

Keypad

Use the keypad to enter your workout session selections.

Note: The EFX5.33 has a stationary ramp. The RESISTANCE keys replace the CROSSRAMP keys shown in this diagram.

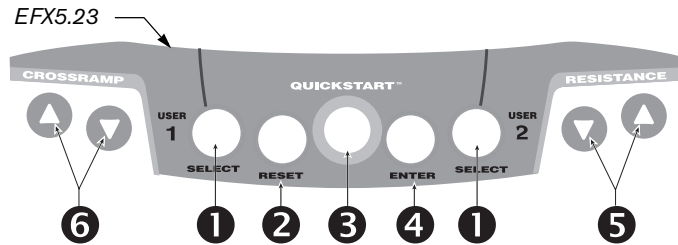

- 1 SELECT:** The SELECT keys have three functions:
 - To select a user ID before starting a workout. Refer to *Selecting a User ID*.
 - To get specific information during a workout. Each SELECT key affects the column above it. Indicator lights appear next to the item that is displayed.
 - To activate scanning mode and select the information that appears. Refer to *Changing the Display Features Using the SELECT Key*.

- 2 RESET:** During pause mode, press the RESET key to display a **WORKOUT SUMMARY**. Press RESET again to return to the Precor banner. No workout statistics are saved.
- 3 QUICKSTART:** Press QUICKSTART to bypass the setup prompts and start your workout immediately using the Manual Program. Refer to *Choosing QUICKSTART*.
- 4 ENTER:** Use the ENTER key to enter responses to workout-specific prompts.
- 5 RESISTANCE ▼▲:** Press and hold the RESISTANCE arrow keys to increase or decrease the force applied against your stride from 1 to 20.

When changes occur, the resistance you feel through the foot pedals is not immediate.

Note: During your workout, to view the current resistance, tap either RESISTANCE ▼ or ▲ key. To change the resistance, press the arrow key for more than one second.

6 CROSSRAMP ▲ ▼ (EFX5.23):

Press and hold the CROSSRAMP arrows to increase or decrease the ramp incline from 1 to 20.

Changes to the ramp incline are not immediate. It takes time for the lift to reach the target incline shown on the display.

Important: Ramp changes occur only when the foot pedals are in motion. The number that appears on the display indicates the selected range, not the degree of incline. There is not a one-to-one relationship between the degree of incline and the CrossRamp setting.

Table 3 shows the degree of incline for each CrossRamp setting.

Table 3. Incline movement

Unit	Incline Setting	Degree of Incline
EFX5.23	1 through 20	13° through 40°
EFX5.33	Stationary	Fixed at 20°

The incline setting affects the column height in the program profile as shown in Diagram 8.

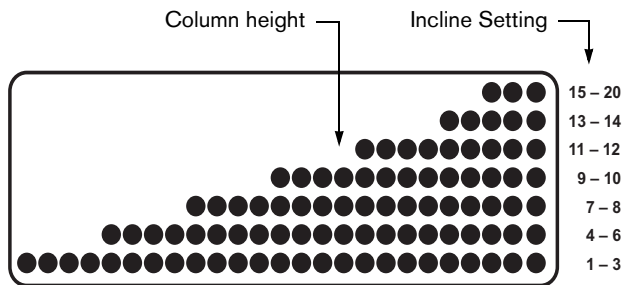

Diagram 8: Column height affected by changes in incline

Note: During the setup phase, pressing the CROSSRAMP arrow keys will not affect the ramp incline. However, the arrow keys do affect what appears on the display. Refer to *Selecting a Program*.

Changing the Display Features Using the SELECT Key

Use the SELECT key to choose which feature appears on the display. When you enter a program, TIME and PROFILE are preselected and will appear in the center display.

You can display different information while you exercise by pressing the appropriate SELECT key. When the light next to the feature turns on, the information appears in the center display.

The EFX can scan between a number of the features so you do not need to press a key once scanning is set up. To set up the scanning process, switch the indicator light next to an item on or off. If the indicator light is off, the item will not appear in the display. If the indicator light is on, the EFX includes it in the scan.

Select TIME, STRIDES, CALORIES, or DISTANCE with the left SELECT key.



Select PROFILE, STRIDES/MINUTE, CALORIES/MINUTE, or WATTS with the right SELECT key.

To add an item to the scanning process:

- Lightly tap the SELECT key until the appropriate indicator lights up. You must then press and hold the SELECT key for at least two seconds. The indicator light blinks until you release the key. During the next scan, the LED lights and the associated information appears.

To turn off an indicator light and remove the item from the scanning process:

- When the indicator light next to the item is lit, press and hold the SELECT key for at least two seconds. The indicator light blinks until you release the key. The next time the EFX performs a scan, the indicator remains blank and the associated information does not appear.

Workout Options

CAUTION: Before beginning any fitness program, see your physician for a complete physical examination. Know your physician-recommended heart rate target zone.

1. Turn the unit ON. The Precor banner appears in the center display.

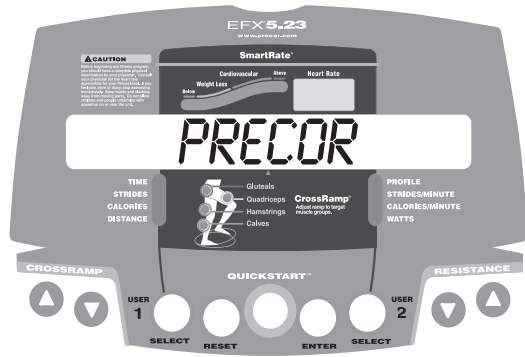

2. Remove the locking pin that secures the roller arm and store it underneath the ramp.
3. Hold on to the stationary handrail and step on the foot pedals.

4. When you are comfortably situated, begin pedaling.
5. Select one of the following options:

Option 1: Use the QUICKSTART key
Choose this option to start your workout immediately. Refer to *Choosing QUICKSTART*.

Option 2: Use the USER 1 or USER 2 key
Select USER 1 or USER 2 to personalize your workout session. Preferences are stored with your user ID and reapplied the next time you select the same one. Choosing a user ID enables the EFX to identify you and remember your last program, workout time, weight, age, and other information specific to the chosen program. A second user ID allows a second person to customize, store, and retrieve workout selections. Refer to *Selecting a User ID*.

Option 3: Use the ENTER key
Choose this option for a customized approach. The display walks you through the preferences for a program, workout time, weight, and age. Workout session information is not retained for future retrieval. Refer to *Selecting a Program*.

Choosing QUICKSTART

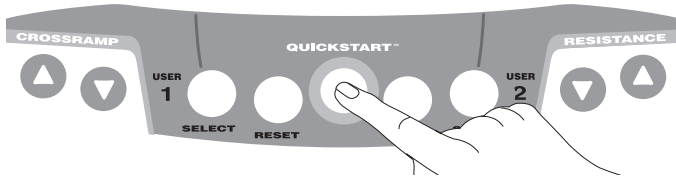

1. Press QUICKSTART at the Precor banner to bypass the setup prompts and access the Manual (MANL) Program.

QUICKSTART applies the following defaults:

Prompts	Default Value
Program	Manual (MANL)
Time	No limit (INFINITE)
Weight	150 lb (68 kg)
Age	0

To use the SmartRate feature, you need to specify your age. In this case, enter a user ID or press ENTER. Follow the setup prompts to enter your age. Press QUICKSTART after your age is displayed.

Note: To retrieve information about your workout session, select USER 1 or USER 2 at the Precor banner, and then press QUICKSTART. Refer to *Selecting a User ID*.

2. Use the RESISTANCE ▲▼ or CROSSRAMP ▲▼ keys to change the resistance and ramp incline (EFX5.23).
3. Maintain a consistent stride rate while exercising. Find a comfortable stride rate between 100 and 150 strides per minute.

Selecting a User ID

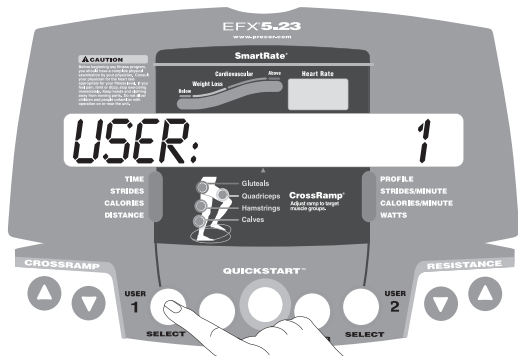

Choosing a user ID enables the EFX to identify you and track your cumulative workout statistics. It also lets you personalize your workout session and stores information about your preferred program, workout time, weight, and age. Up to two people can select their own user ID and personalize their workout sessions.

1. At the Precor banner, press the USER 1 or USER 2 key.

2. When the USER 1 or USER 2 prompt appears, choose an option:

Option 1: Press QUICKSTART

Start your workout using the existing preferences associated with the user ID displayed.

Option 2: Press ENTER

Enter or change your preferences for a program, workout time, weight, age, and other information specific to the chosen program. Workout preferences are saved with your user ID and reapplied to your workout session the next time you select the same user ID.

Important: Press QUICKSTART after any of the prompts (program name, weight, or age entry) to apply existing user ID preferences to any prompts you skipped.

Note: During a workout, the functionality of the SELECT keys change and affect what items appear on the display. Refer to *Changing the Display Features Using the SELECT Key*.

3. Use the RESISTANCE ▲▼ or CROSSRAMP ▲▼ keys to change the resistance and ramp incline (EFX5.23).
4. Maintain a consistent stride rate while exercising. Find a comfortable stride rate between 100 and 150 strides per minute.

Selecting a Program

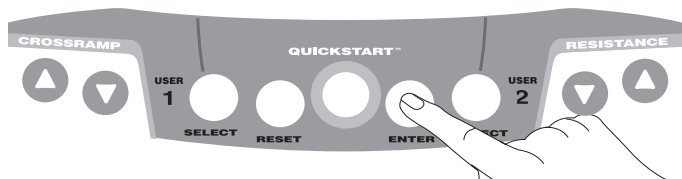

1. At the Precor banner, press ENTER, and then press the arrow keys to cycle through the available programs. Refer to Table 4.

The abbreviated program name and a portion of the program profile appear in the display.

2. Select the program you want, and then press ENTER.

Table 4. Available programs

<i>Program</i>	<i>EFX5.23</i>	<i>EFX5.33</i>
Manual	MANL	MANL
Crosstraining™	XCTR	XCTR
Gluteal	GLUT	–
Hill Climb	–	HILL
Interval Course 1	INT1	INT1
Interval Course 2	INT2	INT2
Interval Course 3	INT3	INT3
Random	RAND	RAND
Weight Loss	WTLS	WTLS
Fitness Test *	FITN	FITN
Heart Rate Control *	HRC	HRC
Custom Course 1	CST1	CST1
Custom Course 2	CST2	CST2
Calories Goal	CALS	CALS
Distance Goal	DIST	DIST

* Requires the chest strap.

3. A program time blinks in the center display. If a time from the previous workout is available, it replaces the default time. Press the arrow keys to select a program time (between 0 and 240 minutes) and then press ENTER.

Note: If you select a zero time limit, INFINITE appears in the display and designates an infinite workout time. If you choose INFINITE, remember to incorporate a cool-down period at the end of your workout.

4. Enter your weight (1–999) and then your age (1–99).
5. To change a value (program, workout time, weight, or age) that you have already entered, press RESET and reenter the information.

Note: You can press QUICKSTART after any of the prompts (program name, workout time, weight, or age entry). QUICKSTART applies the existing preferences and uses default settings for any prompts you skipped.

6. Use the RESISTANCE ▲▼ or CROSSRAMP ▲▼ keys to change the resistance and ramp incline (EFX5.23).
7. Maintain a consistent stride rate while exercising. Find a comfortable stride rate between 100 and 150 strides per minute.

Cooling Down After a Workout

Incorporate a cool-down period into your workout to help lower your heart rate and minimize muscle stiffness or soreness.

When you complete a program with a time limit, calorie goal, or distance goal, you automatically enter a 5-minute cool-down period. The Manual (MANL) Program profile appears in the display and resistance reduces by 20%. To change the resistance or ramp incline, press the arrow keys.

A workout summary appears at the end of the 5-minute cool-down period. See *Ending a Workout*.

Important: If you press QUICKSTART or enter a time of INFINITE, the automatic 5-minute cool-down period does not occur. If you exit a program before completing it, the cool-down period is also bypassed.

To prematurely end the 5-minute cool-down period do the following:

1. Grasp the stationary handrail with one hand.
2. Press RESET with your other hand to view the workout summary.
3. Press RESET again to return to the Precor banner.

Pausing During a Workout or the Cool-Down Period

Stop pedaling to pause anytime during a workout or during a cool-down period. The pause mode is limited to ten minutes. If you do not resume pedaling during that time, the display returns to the banner.

Press the RESET key to view the workout summary. Press RESET again to return to the Precor banner.

Note: To resume exercising from pause mode, press SPEED ▲. If password protection is enabled, you are prompted for the password.

Ending a Workout

CAUTION: Hold on to the stationary handrail when you near the end of a workout.

You can stop pedaling when you complete the automatic cool-down period, or end your workout by pressing the RESET key.

The WORKOUT SUMMARY shows your cumulative workout statistics including warm-up and cool-down periods. Other information including strides per minute, calories per minute, and watts reset to zero. You can review your workout statistics for ten minutes before the display resets to the banner.

To return to the banner before the ten minutes elapse, press RESET.

Programs

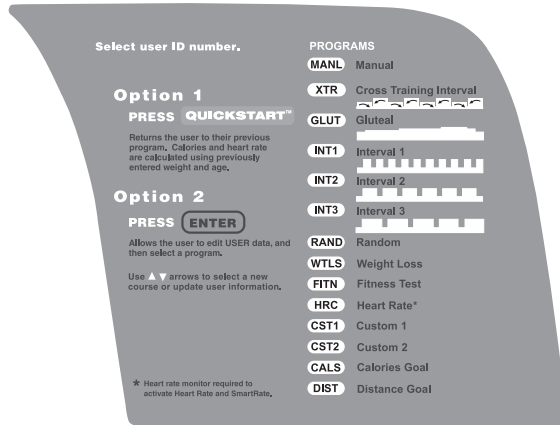

Diagram 9: EFX5.23 program label

This section describes the programs printed on the display label. The programs on the EFX5.23 and EFX5.33 are identical except for the Gluteal and Hill Climb programs, which provide a preprogrammed incline (Gluteal, EFX5.23) and preprogrammed resistance (Hill Climb, EFX5.33).

Note: Some units display XCTR instead of XTR for the Crosstraining Program. Custom courses only appear if you select a user ID.

Choosing a Program

Choosing a program depends on your goals. If you are a beginner or returning to regular exercise, you can start a cardio-conditioning program to slowly return your body to a comfortable level of exercise. If you have been exercising and feel that you have an intermediate or advanced fitness level, you probably have established goals. The Precor web site (www.precor.com) can give you many ideas about fitness workouts and advice from the experts.

Several workout choices on the EFX are preprogrammed with recommendations for incline levels or resistance, backward or forward motion, and alternating rest or work intervals. You always have the option to override the suggested levels with the exception of the Fitness Test (FITN) and the Heart Rate Control (HRC) Program.

If your level of exertion becomes too great, reduce your stride rate or use the arrow keys to override each upcoming column in the program profile. If you use the arrow keys, the profile changes accordingly. When you complete a program that contains a time goal or distance limit, an automatic 5-minute cool-down period begins.

The table below shows a variety of program options.

Table 5. Program options

<i>Preferences</i>	<i>MANL</i>	<i>XCTR</i>	<i>GLUT</i>	<i>HILL</i>	<i>INT(n)</i>	<i>RAND</i>	<i>WTLS</i>	<i>FITN</i>	<i>HRC</i>	<i>CST</i>	<i>CALS</i>	<i>DIST</i>
Preset incline			X			X		X				
Preset resistance				X		X		X	X			
Goal-based											X	X
Backward/Forward intervals		X										
Rest/Work intervals					X		X					
Fixed time limit							X					
Heart rate controlled*								X	X			
Arrow keys can change incline or resistance	X	X	X	X	X		X			X	X	X

* Requires that the user wear a chest strap.

Program Tips

- Work out indefinitely in any program (except Weight Loss). At the time prompt, use the arrow keys to select INFINITE. The TIME display indicates the amount of time you have been exercising. If you choose to exercise without a time limit, the automatic 5-minute cool-down period is eliminated. you will need to incorporate a cool-down period by accessing the Manual Program.
- Place a time limit on any program during the setup phase. At the time prompt specify the time duration for your workout. When you exercise, TIME shows the amount of time remaining.
- Maintain your stride rate between 100 and 150 strides per minute. Dropping below 20 strides per minute places the EFX in pause mode.
- A blinking column tracks the progress that you make during a program.

Note: The EFX5.33 has a stationary ramp. All references to ramp incline apply to the EFX5.23.

Manual (MANL) Program

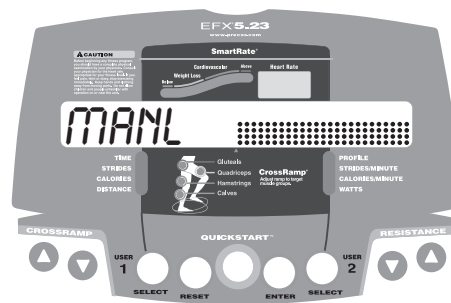

You control the resistance and incline settings when you use the Manual Program. The profile begins as a flat line. Use the arrow keys to change the resistance or to adjust the ramp incline. The program profile reflects changes to resistance on the EFX5.33 and changes to incline on the EFX5.23. The blinking column indicates your position in the program.

If you press QUICKSTART at the banner and access the Manual Program, the workout time is infinite. A cool-down period does not automatically occur when you end your workout. Always remember to incorporate a cool-down period into your workout.

To use the SmartRate feature, you need to specify your age. Refer to *Selecting a Program*.

Note: In the Manual Program, the EFX5.23 ramp incline defaults to level 9.

Crosstraining (XCTR) Program

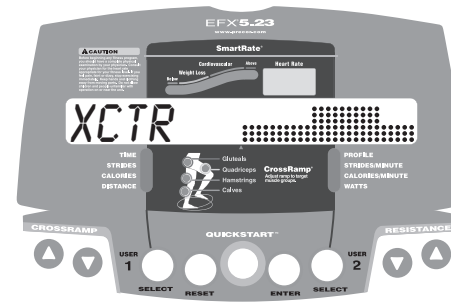

This program consists of alternating forward and backward pedaling movements, in 1-minute segments, to focus on working the thigh and calf muscle groups. Display prompts indicate when you should change pedal direction.

You can set the resistance and ramp incline levels during the forward and backward intervals. The program remembers your settings and repeats them for subsequent forward and backward intervals until you change them.

Gluteal (GLUT) Program

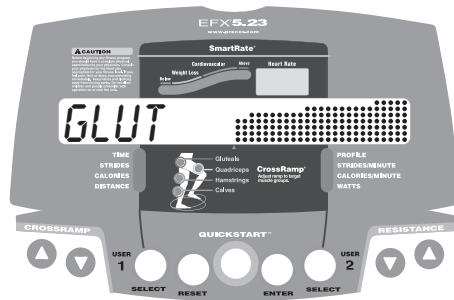

The ramp incline on the EFX5.23 Gluteal Program is preprogrammed. Review the program label on the display console to determine the ascent and descent levels of the program.

Anytime during a workout, you can override the incline settings by pressing the CROSSRAMP arrow keys. The remaining profile columns change accordingly.

You can adjust the resistance by pressing the RESISTANCE arrow keys. Unlike the ramp incline settings, the resistance changes made while using the program are not saved.

Hill Climb (HILL) Program

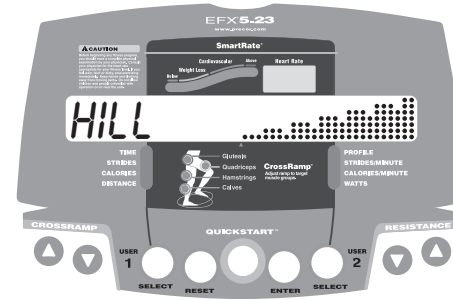

The resistance in the EFX5.33 Hill Climb Program is preprogrammed. To override the resistance settings for each column, press the RESISTANCE arrow keys. The changes raise or lower the columns on the remaining portion of the program profile.

Interval (INTn) Program

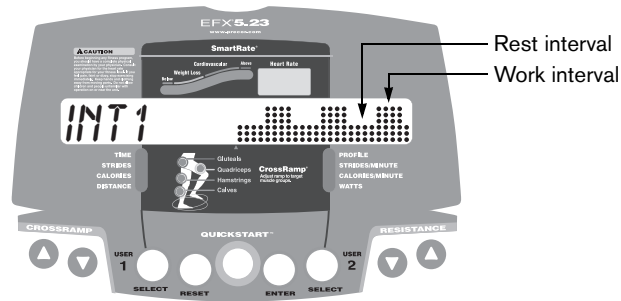

The Interval Program is among the best for conditioning your cardiovascular system. Each program raises and lowers your level of exertion repeatedly for a specified period of time.

When you select an Interval Program, you are prompted to set the duration of the rest and work intervals. To select the displayed number, press ENTER, or change the interval duration from 1 to 9 minutes using the arrow keys.

<i>Interval Programs</i>	<i>Default Settings</i>	
	<i>Rest duration</i>	<i>Work duration</i>
INT1	1 minute	1 minute
INT2	1 minute	2 minute
INT3	1 minute	3 minute

When you begin the program, you are prompted to set the resistance and ramp incline for the first rest and work intervals. The settings are repeated throughout the program.

To change the settings, press the appropriate arrow key and continue. The changes are applied to the remaining intervals. The display lets you know when the resistance or incline levels are about to change, and indicates the levels of the next segment.

When you complete the program, the resistance and ramp incline settings are saved and applied the next time you select the same Interval Program.

Random (RAND) Program

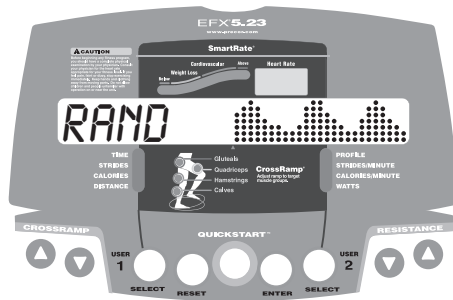

Every time the Random Program is selected, a different program profile appears. The 1-minute columns that appear in the profile maintain a set incline or resistance.

To override the settings, use the arrow keys. The maximum change allowed between columns is plus or minus four levels of incline or resistance.

Weight Loss (WTLS) Program

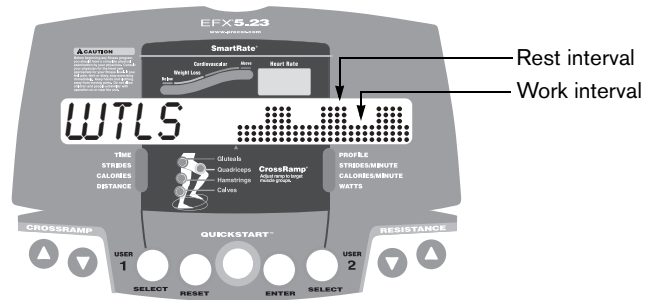

With the Weight Loss Program, the workout time is fixed at 28 minutes and consists of seven, 4-minute intervals. You are not prompted for a workout time. Use the arrow keys to change the resistance or the incline for the rest or work interval. When you make changes, the program repeats the settings for the remaining intervals.

The display lets you know when the resistance levels are about to change.

For the ideal weight loss range, your heart rate should be between 55% and 70% of your maximum aerobic heart rate. If you wear the chest strap, you can use SmartRate as a visual cue.

- Set a comfortable stride rate and then adjust the resistance and ramp incline.
- Maintain a level of exertion so that the first yellow LED blinks in the SmartRate display during rest intervals.
- During the work intervals, increase your level of exertion so that the first green LED blinks.

For more information about the SmartRate display, refer to *Using SmartRate*.

Fitness Test (FITN)

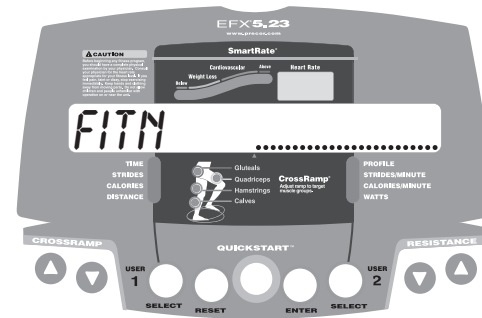

The Fitness Test Program provides a 5-minute test. You cannot adjust the resistance or ramp incline levels. When you complete the test, the display provides a fitness score and fitness category.

The Fitness Test measures the maximum amount of oxygen (VO_{2max}) the body can use for energy production during exercise. The higher the amount of oxygen that your body can use enhances your ability to exercise for prolonged periods of time. The test results can help you gauge the effectiveness of your current exercise routine and tailor it to meet your fitness goals.

Guidelines

Before selecting the Fitness Test, read the following guidelines:

- Sit and rest for at least five minutes prior to taking the test to bring your heart rate to a resting state.
- The fitness score is affected by your weight, age, and gender. You must enter this data during the setup phase. Prompts appear after selecting program FITN.
- You must wear the chest strap throughout the test.
- The arrow keys are disabled during the test. Any pressure on the arrow keys is ignored.

Warm-up Period

When you access the fitness test, the following occurs:

- A gender prompt appears. Use the arrow keys to toggle between gender selection and then press ENTER.
- The EFX provides a warm-up period before beginning the 5-minute fitness test. The warm-up period has a time limit of 25 minutes. Instructions appear and direct you to pedal at a constant stride rate of 70 strides per minute. The pace is increased until your heart rate reaches 55% of the maximum heart rate (220 minus your age) or the pace reaches 160 strides per minute. In either case, the fitness test commences at this point.

Using the Fitness Test

Maintain a constant stride rate, but let the program adjust the resistance for you. During the warm-up period the resistance is set at level 3. At the beginning of the 5-minute Fitness Test, the resistance automatically raises to level 9.

CAUTION: If you need to stop pedaling to regain control or reduce your heart rate, please do so—you can retake the Fitness Test later.

Completing the Fitness Test

When you finish the Fitness Test, the pedal resistance is reduced. No automatic cool-down period is provided after the test.

Create your own cool-down period by pressing the QUICKSTART key to enter the Manual Program and return your heart rate to a normal, restful state.

The fitness test automatically ends if one of the following occurs:

- You stop pedaling.
- Your heart rate increases and remains for one minute above 85% of the maximum allowable heart rate (220 minus your age).

- You press RESET.
- You complete the test.

Important: *The Fitness Test continues even though a user walks away part way through the test or removes the chest strap. The test score will not be accurate because no reception (and therefore no measurement) of the heart rate was available at the end of the test period.*

Fitness Test Scores

When you complete the fitness test, your cardiorespiratory fitness category is shown in the workout summary. Refer to Table 6 and Table 7.

Note: If no heart rate is detected at the end of the fourth minute and through to the end of the test, N/A appears as the fitness score.

Tables 6 and 7 show the desired range in fitness levels depending on your age and gender. More information is available at the Precor web site (www.precor.com).

Table 6. Cardiorespiratory Fitness Score Category–Females*

Age in Years	Fitness Category				
	Poor	Fair	Good	Superior	Excellent
30 (or below)	32 (or below)	32–34	35–37	38–41	42 (or above)
30–39	30 (or below)	30–32	33–35	36–39	40 (or above)
40–49	28 (or below)	28–30	31–32	33–36	37 (or above)
50–59	25 (or below)	25–27	28–29	30–32	33 (or above)
60 and over	24 (or below)	24–25	26–27	28–31	32 (or above)

* *The Physical Fitness Specialist Certification Manual*, The Cooper Institute for Aerobics Research, revised 1997.

Table 7. Cardiorespiratory Fitness Score Category–Males*

Age in Years	Fitness Category				
	Poor	Fair	Good	Superior	Excellent
30 (or below)	38 (or below)	38–41	42–44	45–48	49 (or above)
30–39	36 (or below)	36–39	40–42	43–47	48 (or above)
40–49	34 (or below)	34 –37	38–40	41–44	45 (or above)
50–59	31 (or below)	31–34	35–37	38–41	42 (or above)
60 and over	27 (or below)	27–30	31–34	35–38	39 (or above)

* *The Physical Fitness Specialist Certification Manual*, The Cooper Institute for Aerobics Research, revised 1997.

Heart Rate Control (HRC) Program

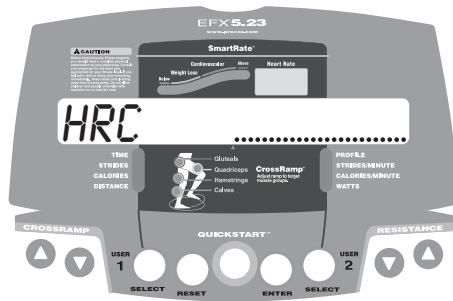

The Heart Rate Control Program lets you set a target for your heart rate. The program adjusts the resistance to maintain your heart rate within two beats per minute of the target heart rate while you exercise. To use this program, you must wear the chest strap so the program can monitor your heart rate throughout the session.

During your workout, the number that represents your heart rate appears in the Heart Rate display.

For information about understanding your target heart rate, refer to *Heart Rate Features*.

Important: Consult your physician to determine the appropriate target heart rate for your age and fitness level. If your physician recommends a different target heart rate than the one that appears on the display, use the appropriate **RESISTANCE** arrow keys to change the target heart rate once you finish the warm-up period. Do not exercise over the recommended range.

Warm-up Period

The EFX provides a 3-minute warm-up period. During this time, you may change the resistance or ramp incline.

Note: If your heart rate moves into the target heart rate zone during the 3-minute warm-up period, the warm-up period ends and the Heart Rate Control Program begins.

Using the HRC Program

When you access the HRC Program, the following occurs:

- The EFX automatically adjusts the resistance to keep your heart rate at the selected target. Pressing the RESISTANCE arrow keys no longer affects the resistance applied to your stride, but does change the target heart rate. Check the SmartRate display to see if you are maintaining your preferred zone (weight loss or cardiovascular). Check the Heart Rate display to determine your actual heart rate.

Important: Maintain a constant stride rate between 100 and 150 strides per minute. Automatic adjustments to the resistance cannot take place if you drop below 20 strides per minute.

- You can change the target heart rate, strides per minute, or ramp incline, but doing so affects the unit's ability to maintain your target heart rate in the preferred zone. It takes time for the EFX to readjust the resistance so that your heart rate remains on target.
- When you complete the program, remember to add a cool-down period.

Note: If you are having difficulty with the heart rate features, refer to *Troubleshooting Heart Rate*.

Custom (CST1 or CST2) Programs

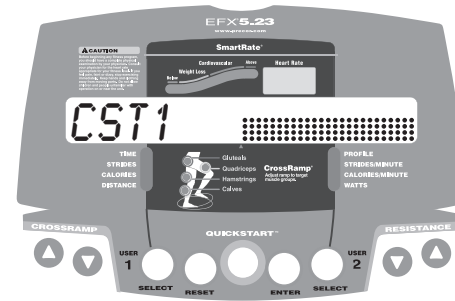

Two custom programs are available with each user ID. As you exercise, you customize the program by determining the resistance or incline settings for each 1-minute column along the length of the profile. As each column elapses, the resistance and incline for that column is stored in memory.

The subsequent columns repeat the last programmed resistance or incline and are reflected in the program profile. Change the resistance or incline using the arrow keys. When you complete the program, the settings are automatically recalled using the same user ID and program number.

During the course, the TIME display relates to the amount of time remaining in the recorded columns. Total elapsed time appears when you record new columns.

Note: The length of the custom program and number of resistance and incline settings are limited to the available memory in the EFX. The program will not end if the available memory is exhausted, but the display notifies you and further changes to resistance or incline are not saved. Approximately six hours of recording time is available for the two user IDs.

Clearing the Settings on a Custom Program

Perform the following steps to clear (delete) any resistance or incline settings stored in a custom program.

1. At the Precor banner, press USER 1 or USER 2, and then press ENTER.
2. Use any arrow key to specify the custom program (CST1 or CST2) that you wish to clear.

Important: *Clearing the resistance and incline settings from a custom program permanently deletes them from memory.*

3. Press and hold the SELECT key associated with the user ID specified earlier for ten seconds. A prompt appears on the display indicating that you are holding the key to clear a custom program. After the message CLEARED appears on the display, you can release the key.

Note: During the 10-second delay, you can release the SELECT key and no change will occur to the custom program settings.

Calories (CAL) Program

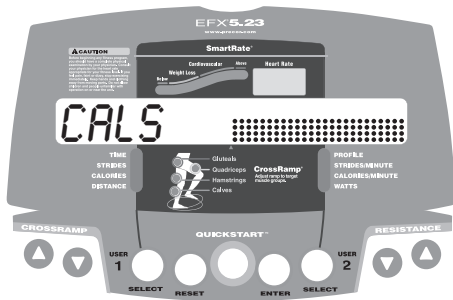

This program lets you designate a fixed calorie goal. When you reach your goal, the program ends and the automatic 5-minute cool-down period begins.

After selecting the Calories Program, specify your calorie goal at the prompt. Acceptable entries range from 1 to 5000 calories. Use the arrow keys to change the value, and then press ENTER to begin.

Distance (DIST) Program

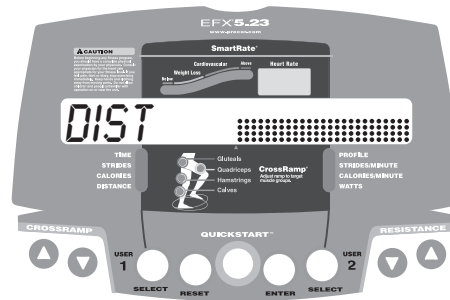

This program lets you designate a fixed distance. When you reach your goal, the program ends and the automatic 5-minute cool-down period begins.

After selecting the Distance Program, specify your distance goal at the prompt. Acceptable entries are from 0.1 to 50. Use the arrow keys to change the value, and then press ENTER to begin.

Note: To change the distance settings from mile to kilometers, follow the instructions in *Selecting a U.S. Standard or Metric Display*.

Advanced Programming and Troubleshooting

Certain features remain hidden and can only be accessed using special key presses. Read this section if you want to:

- Change the display to U.S. Standard or Metric
- View the odometer
- Display the number of hours you have used your EFX
- View the software versions and hardware part numbers
- Check the error log
- Display the serial number

Advanced Programming Tips

- Always start at the Precor banner.
- The advanced programming and diagnostic mode is accessed by pressing the RESET key at the Precor banner. The remaining key presses must occur quickly and without pause.
- The function of the QUICKSTART key is disabled while in diagnostics mode.
- Exit the diagnostics mode by pressing the RESET key for two or more seconds. The display remains blank for one second and any additional key presses are ignored.

Selecting a U.S. Standard or Metric Display

The EFX can display measurements in either U.S. Standard (U.S. STD) or METRIC. The default factory setting is set to display U.S. STD. To change this setting, perform the following steps:

1. At the Precor banner, press the following keys in sequence and without pause:

RESET, QUICKSTART, ENTER, SELECT [USER 2],
CROSSRAMP ▲

Note: No CROSSRAMP keys exist on the EFX5.33. Use the RESISTANCE ▲ key on the left side of the keypad.

As shown in Diagram 10, numbers are associated with the keypad. The numbers 5, 6, 7, 1 appear on the display as you press the associated key.

EFX5.23

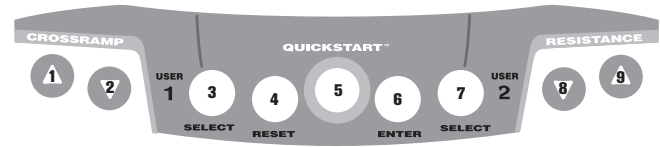

EFX5.33

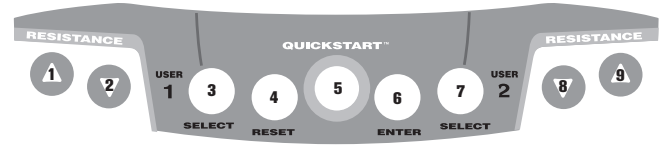

Diagram 10: Keypad programming numbers

2. SELECT UNITS appears, followed by the current unit of measure (U.S. STD or METRIC). Use an arrow key to switch between the options.
3. Press ENTER to accept the displayed setting.
The change will be retained in memory even if the EFX is turned OFF and unplugged.
4. Press RESET to return to the Precor banner.

Informational Displays

The EFX provides information about its use (odometer and hour meter), as well as software version, error log, and serial number. In general, you would only access this information if directed to do so by Precor Customer Support.

These instructions guide you through all five informational displays. Pressing the ENTER key moves you through the displays. To exit, press the RESET key at any time.

Viewing the Odometer

1. At the Precor banner, press the following keys in sequence and without pause:
RESET, ENTER, QUICKSTART

Numbers 6, 5 appear on the display as you press the associated key.

ODOMETER appears on the display followed by the odometer value (the number of cumulative strides users have taken).
2. Press either SELECT key, and STRIDES appears briefly. The number appearing on the display represents the unit's total strides.
3. When you are ready, press ENTER to move to the next display (hour meter).

Viewing the Hour Meter

HOUR METER appears on the display followed by the number of hours that the unit has been in use. The EFX tracks the elapsed minutes, but the value that appears is truncated to the nearest full hour.

4. Press either SELECT key, and HOURS appears briefly.
5. When you are ready, press ENTER to move to the next display (software version).

Viewing the Software Version and Part Numbers

SW VERSION appears for two seconds. UPPER then appears followed by the upper board software part number (for example, 46923-205).

6. To view the lower board's software versions, press either SELECT key. LOWER appears briefly followed by the version number.

After the upper and lower board software versions, UPPER BOOT appears and provides the upper boot part number (for example V47475-205). The first five numbers relate to the boot software part number and the last three digits indicate the boot version number.

7. Write the numbers in the space below. You will need these numbers when you call Customer Support with display-related questions. This information will help rule out any software-related problems:

Upper Board P/N: _____

Lower Board P/N: _____

Upper Boot Software P/N: _____

Upper Boot Version Number: _____

8. When you are ready, press ENTER to move to the next display (error log).

Viewing the Error Log

ERROR LOG appears on the display followed by the first entry in the error log if there are any errors. Up to ten error codes can be retrieved.

1: ER33

Diagram 11: Error log

If there are no errors in the log, you will see three dash lines (— — —) appear in the display.

The following describes key functionality within the error log.

<i>Key</i>	<i>Description</i>
▼	Displays the most recent error log entries
▲	Reveals earlier log entries
SELECT	Toggles between the error log, the odometer reading and the hour meter values at the time the error occurred; a title (i.e., STRIDES or HOURS) appears briefly followed by the actual numeric value associated with the error log

9. Copy the error code information to paper so you can provide it to Customer Support if needed. Be sure to copy it exactly as shown.

10. When you no longer need the information in the error log, press QUICKSTART for at least four seconds to erase the error log. Continue to maintain light pressure on the key until the message CLEAR? appears. Wait four seconds until OK appears, and then release the key.

Important: *You cannot retrieve the error log once you have deleted it.*

When the error log is cleared, 1: – – – appears in the display indicating that the error messages have been deleted.

11. When you are ready, press ENTER to move to the next display (serial number).

Displaying the Serial Number

SERIAL NUMBER appears. The serial number is helpful when you contact Customer Support.

12. If you have not already done so, write the serial number onto the Warranty Registration card. You can also register online at www.precor.com.
Note: If no serial number has been entered, then NONE appears. Use the serial number found on a label on the rear cover (Diagram 2).
13. When you are ready, press ENTER to return to the Precor banner.

Troubleshooting Error Codes

If any error codes appear in the center display, call an authorized service person for assistance. Refer to *Obtaining Service*.

Troubleshooting Heart Rate

Table 8 may help you understand and troubleshoot erratic heart rate readings.

Important: A heart rate can only be detected when the Precor heart rate receiver is properly installed in the display and the EFX is turned ON. You must also wear the chest strap.

Table 8. Erratic heart rate readings

<i>What appears on the display</i>	<i>Cause</i>	<i>What to Do</i>
NO HR RECEIVER INSTALLED	The heart rate receiver is not installed or it has been disconnected.	To reinstall the heart rate receiver, contact Customer Support. Refer to <i>Obtaining Service</i> .

<i>What appears on the display</i>	<i>Cause</i>	<i>What to Do</i>
-- --	A heart rate is not detected.	Be sure the heart rate receiver is installed properly and that the chest strap is moist, centered, and in direct contact with your skin.
Pulsing HR LED	The LED lights briefly when a heart beat is detected.	If the LED is pulsating, it indicates that the heart rate equipment is working properly.

Note: To conduct electrical impulses from a user's heart, the electrode strips on the chest strap must be in contact with the user's skin. Usually, the concentration of salts in a person's perspiration provides enough conductivity to transmit a signal to the receiver in the display console. However, because of body chemistry or erratic heartbeats, some people cannot use the heart rate feature.

Maintenance

It is important to perform the minor maintenance tasks described in this section. Failure to maintain the EFX as described here could void the Precor Limited Warranty.

DANGER To reduce the risk of electrical shock, always unplug the unit from its power source before cleaning it or performing any maintenance tasks.

Inspection

Inspect the EFX daily.

Look and listen for slipping belts, loose fasteners, unusual noises, worn or frayed power cords, and any other indications that the equipment may be in need of service. If you notice any of these, obtain service.

Important: If you determine that the EFX needs service, turn the unit OFF. Insert the locking pin, and then remove the power cord so it cannot be used. Make sure other users know that the EFX needs service.

To order parts or to contact a Precor authorized service provider in your area, refer to *Obtaining Service*.

Cleaning the Equipment

Most of the working mechanisms are protected inside the casing. However, for efficient operation, the EFX relies on low friction. To keep the friction low, the EFX rollers, rails, and internal mechanisms must be as clean as possible.

Precor recommends the EFX be cleaned before and after each workout. Use a damp, soft cloth to clean all exposed surfaces. This helps remove any dust or dirt that might affect the smooth operation of the unit.

To clean the ramp and roller wheels, position one foot pedal at the top of the ramp (the other will automatically be positioned at the bottom). Clean the exposed surfaces of the ramp and roller wheels daily, or whenever the ramp becomes soiled. Switch the foot pedal position to finish cleaning the ramp. Gently lift the roller wheel and rotate it to clean it.

CAUTION: Do not use any acidic cleaners. Doing so will weaken the ramp coating and void the Precor Limited Warranty. Never pour water or spray liquids on any part of the EFX. Allow the EFX to dry completely before using.

Periodically, clean the grooves on the foot pedals using a soft nylon scrub brush. Frequently vacuum the floor underneath the unit to prevent the accumulation of dust and dirt, which can affect the smooth operation of the unit.

Storing the Chest Strap

Store the chest strap where dust and dirt cannot accumulate on it, such as a closet or drawer. Be sure to keep the chest strap protected from extremes in temperature. Do not store it in an area that may be exposed to temperatures below 32° F (0° C).

To clean the chest strap, use a sponge or soft cloth dampened in mild soap and water. Dry the surface thoroughly with a clean towel.

Servicing the EFX

Do not attempt to service the EFX yourself except for the maintenance tasks described in this manual. The unit does not contain any user-serviceable parts that require lubrication. For information about product operation or service, call 1-800-347-4404.

Long-Term Storage

When the EFX is not in use for any length of time, turn it OFF. Ensure that the power cord is unplugged from the wall outlet and is positioned so that it will not become damaged or interfere with people or other equipment. Insert the locking pin through the roller arm to secure the EFX.

Precor Residential Equipment Limited Warranty

PLEASE READ THESE WARRANTY TERMS AND CONDITIONS CAREFULLY BEFORE USING YOUR PRECOR INCORPORATED PRODUCT. BY USING THE EQUIPMENT, YOU ARE CONSENTING TO BE BOUND BY THE FOLLOWING WARRANTY TERMS AND CONDITIONS.

Limited Warranty

Precor Incorporated warrants all new Precor products to be free from defects in materials and manufacture for the warranty period set forth below. The warranty period commences on the invoice date of original purchase. This warranty applies only against defects discovered within the warranty period and extends only to the original purchaser of the product. Parts repaired or replaced under the terms of this warranty will be warranted for the remainder of the original warranty period only. To make claim under warranty, the buyer must notify Precor or their authorized Precor dealer within 30 days after the date of discovery of any nonconformity and make the affected product available for inspection by Precor or its service representative. Precor's obligations under this warranty are limited and set forth below.

Warranty Periods and Coverage

All residential products and commercial products used in the home are warranted for the following periods:

- Lifetime frame and welds
- 10 years parts and wear items
- 1 year labor
- Coverage for options and accessories defined below.

Options / Accessories

Many options or accessories have components that are connected internally or mounted inside the electronic console. The following guidelines determine the warranty for these components. If the internal components are installed by the factory or by an authorized dealer as part of the original sale and delivery, they have a warranty that is identical to the warranty of the equipment in which they are connected or mounted. If the internal components are not installed by the factory or by an authorized dealer as part of the original sale and delivery, they have a 90-day parts and labor limited warranty. All components that are not internally connected have 90-day parts only limited warranty. Satisfactory proof of purchase is required in all cases.

Conditions and Restrictions

This warranty is valid only in accordance with the conditions set forth below:

1. The warranty applies to the Precor product only while:
 - a. It remains in the possession of the original purchaser and proof of purchase is demonstrated
 - b. It has not been subjected to accident, misuse, abuse, improper service, or non-Precor modifications
 - c. Claims are made within the warranty period
2. This warranty does not cover damage or equipment failure caused by electrical wiring not in compliance with electrical codes or Precor owner's manual specifications, or failure to provide reasonable and necessary maintenance as outlined in the owner's manual.
3. Warranty of all Precor products applies to residential use only and is void when products are used in a nonresidential environment or installed in a country other than where sold.
4. Except in Canada, Precor does not pay labor outside the United States.
5. Warranties outside the United States and Canada may vary. Please contact your local Dealer for details.

This limited warranty shall not apply to:

1. Software version upgrades
2. Cosmetic items, including, but not limited to the following: grips, seats, and labels.
3. Repairs performed on Precor equipment missing a serial number or with a serial tag that has been altered or defaced.

4. Service calls to correct installation of the equipment or instruct owners on how to use the equipment.
5. Pickup, delivery, or freight charges involved with repairs.
6. Any labor costs incurred beyond the applicable labor warranty period.

Disclaimer and Release

The warranties provided herein are the exclusive warranties given by Precor and supersede any prior, contrary or additional representations, whether oral or written. ANY IMPLIED WARRANTIES, INCLUDING THE WARRANTY OF MERCHANTABILITY OR FITNESS FOR A PARTICULAR PURPOSE THAT APPLY TO ANY PARTS DESCRIBED ABOVE ARE LIMITED IN DURATION TO THE PERIODS OF EXPRESS WARRANTIES GIVEN ABOVE FOR THOSE SAME PARTS. PRECOR HEREBY DISCLAIMS AND EXCLUDES THOSE WARRANTIES THEREAFTER. Some states do not allow limitation on how long an implied warranty lasts, so the above limitation may not apply to you. PRECOR ALSO HEREBY DISCLAIMS AND EXCLUDES ALL OTHER OBLIGATIONS OR LIABILITIES, EXPRESS OR IMPLIED, ARISING BY LAW OR OTHERWISE, WITH RESPECT TO ANY NONCONFORMANCE OR DEFECT IN ANY PRODUCT, INCLUDING BUT NOT LIMITED TO: (A) ANY OBLIGATION, LIABILITY, RIGHT, CLAIM OR REMEDY IN TORT, WHETHER OR NOT ARISING FROM THE NEGLIGENCE OF PRECOR OR ITS SUPPLIERS (WHETHER ACTIVE, PASSIVE OR IMPUTED); AND (B) ANY OBLIGATION, LIABILITY, RIGHT, CLAIM, OR REMEDY FOR LOSS OF OR DAMAGE TO ANY EQUIPMENT. This disclaimer and release shall apply even if the express warranty set forth above fails of its essential purpose.

Exclusive Remedies

For any product described above that fails to conform to its warranty, Precor will provide, at their option, one of the following: (1) repair; (2) replacement; or (3) refund of the purchase price. Precor Limited Warranty service may be obtained by contacting the authorized dealer from whom you purchased the item. Precor compensates Servicicers for warranty trips within their normal service area to repair equipment at the owner's location. You may be charged a trip charge outside the service area. THESE SHALL BE THE SOLE AND EXCLUSIVE REMEDIES OF THE BUYER FOR ANY BREACH OF WARRANTY.

Exclusion of Consequential and Incidental Damages

PRECOR AND/OR ITS SUPPLIERS SHALL HAVE NO OBLIGATION OR LIABILITY, WHETHER ARISING IN CONTRACT (INCLUDING WARRANTY), TORT (INCLUDING ACTIVE, PASSIVE, OR IMPUTED NEGLIGENCE AND STRICT LIABILITY), OR OTHERWISE, FOR DAMAGE TO THE EQUIPMENT, PROPERTY DAMAGE, LOSS OF USE, REVENUE OR PROFIT, COST OF CAPITAL, COST OF SUBSTITUTE EQUIPMENT, ADDITIONAL COST INCURRED BY BUYER (BY WAY OF CORRECTION OR OTHERWISE) OR ANY OTHER INCIDENTAL, SPECIAL, INDIRECT, OR CONSEQUENTIAL DAMAGES, WHETHER RESULTING FROM NONDELIVERY OR FROM THE USE, MISUSE OR INABILITY TO USE THE PRODUCT. This exclusion applies even if the above warranty fails of its essential purpose and regardless of whether such damages are sought for breach of warranty, breach of contract, negligence, or strict liability in tort or under any other legal theory. Some states do not allow the exclusion or limitation of incidental or consequential damages, so the above limitation might not apply.

This warranty gives you specific legal rights, and you may also have other rights, which vary state to state.

Effective 01 January, 2003
P/N 36287-110

Thank You and Welcome to Precor



To allow us to serve you better, please take a few moments to complete and return your warranty registration.

YOU MAY ALSO REGISTER ONLINE AT

www.precor.com/warranty

If you have questions or need additional information, contact your local dealer or call Precor Customer Support at 800-347-4404.

Fold along dotted line and tape closed before mailing.

RET.

PRECOR[®] USA
Precor Incorporated
20031 142nd Avenue NE
PO Box 7202
Woodinville, WA 98072-4002

PLACE
STAMP
HERE

TELL US ABOUT YOUR NEW PRECOR PRODUCT

Date of Purchase:

Month	Day	Year
-------	-----	------

Product Serial Number:

--

The serial number is located on the shipping box and on the product.

Purchased from:

--

Dealer Name

Please indicate the type of product purchased:

- | | |
|--|--|
| <input type="checkbox"/> Elliptical Fitness CrossTrainer™ (EFX®) | <input type="checkbox"/> StretchTrainer™ |
| <input type="checkbox"/> Treadmill | <input type="checkbox"/> Cycle |
| <input type="checkbox"/> Strength Training System | <input type="checkbox"/> Stair Climber |

TELL US ABOUT YOU

- Mr.
 Mrs.
 Ms.

First Name	Middle Initial	Last Name
------------	----------------	-----------

Street Address	Apt./Suite:
----------------	-------------

City	State	Zip Code
------	-------	----------

Area Code	Telephone
-----------	-----------

Your Email Address

--

- | | | | | |
|--|--|--|--|--|
| Gender:
<input type="checkbox"/> Male
<input type="checkbox"/> Female | Marital status:
<input type="checkbox"/> Married
<input type="checkbox"/> Divorced
<input type="checkbox"/> Widowed
<input type="checkbox"/> Never been married | Age:
<input type="checkbox"/> Under 18
<input type="checkbox"/> 18-24
<input type="checkbox"/> 25-34
<input type="checkbox"/> 35-44
<input type="checkbox"/> 45-54
<input type="checkbox"/> 55-64
<input type="checkbox"/> 65+ | Annual household income:
<input type="checkbox"/> Under \$50,000
<input type="checkbox"/> \$51,000-75,000
<input type="checkbox"/> \$76,000-100,000
<input type="checkbox"/> \$101,000-150,000
<input type="checkbox"/> \$151,000+ | What are your fitness goals?
<input type="checkbox"/> Weight loss/management
<input type="checkbox"/> Muscle tone enhancement
<input type="checkbox"/> Cardiovascular improvement
<input type="checkbox"/> Overall health
<input type="checkbox"/> Increase energy and flexibility
<input type="checkbox"/> Stress reduction
<input type="checkbox"/> Rehabilitation
<input type="checkbox"/> Other |
|--|--|--|--|--|

TELL US ABOUT YOUR PURCHASE

Purchase (check all that apply):

- First Precor product
- Replaces a Precor product of the same type
- Replaces same type of product – different brand
- Addition to equipment currently owned

What factors MOST influenced your decision to purchase your Precor product (choose up to three):

- | | |
|---|---|
| <input type="checkbox"/> Precor reputation | <input type="checkbox"/> Rebate or sale price |
| <input type="checkbox"/> Prior use of Precor product(s) | <input type="checkbox"/> Quality/durability |
| <input type="checkbox"/> Design/appearance | <input type="checkbox"/> Warranty |
| <input type="checkbox"/> Special product features | <input type="checkbox"/> Value for the price |
| <input type="checkbox"/> Physician recommendation | |

How did you FIRST become aware of Precor products (choose only one):

- A gift
- Friend/relative
- Physician
- Fitness club
- Internet
- News report or product review
- Magazine advertisement or article
- Print advertisement
- In-store display or demonstration
- Other

EFX5.23/EFX5.33 Elliptical Fitness Crosstrainers

Product Specifications

	EFX5.23	EFX5.33
Length:	80 in (203 cm)	80 in (203 cm)
Width:	32 in (81 cm)	32 in (81 cm)
Height:	61 in (155 cm)	64 in (162 cm)
Weight:	197 lb (89 kg)	197 lb (89 kg)
Shipping weight:	245 lb (111 kg)	245 lb (111 kg)
Power:	120VAC, 50/60Hz, 1.7 Amps, 140 Watts	120VAC, 50/60Hz, 0.9 Amps, 70 Watts
CrossRamp®:	13–40°	20°
Incline settings:	1–20	Fixed
Resistance levels:	1–20	1–20
Frame:	Powder-coated steel	Powder-coated steel
Regulatory Approvals:	FCC, ETL, CE	FCC, ETL, CE

Product Features

	EFX5.23	EFX5.33
CSAFE Compatible	✓	✓
Heart Rate Telemetry*	✓	✓
QuickStart™	✓	✓
SmartRate®**	✓	✓
Touch-Sensitive Display	✓	✓
User IDs	2	2

Programs

	EFX5.23	EFX5.33
Manual	✓	✓
Crosstraining™	✓	✓
Gluteal	✓	
Hill Climb		✓
Interval Course 1	✓	✓
Interval Course 2	✓	✓
Interval Course 3	✓	✓
Random	✓	✓
Weight Loss	✓	✓
Fitness Test*	✓	✓
Heart Rate Control*	✓	✓
Custom Course 1	✓	✓
Custom Course 2	✓	✓
Calories Goal	✓	✓
Distance Goal	✓	✓

Display Readouts

	EFX5.23	EFX5.33
Calories	✓	✓
Calories Per Minute	✓	✓
CrossRamp® Incline	✓	
Distance	✓	✓
Heart Rate*	✓	✓
Muscles Targeted	✓	
Profile	✓	✓
Resistance Levels	1–20	1–20
SmartRate®*	✓	✓
Strides	✓	✓
Strides Per Minute	✓	✓
Time	✓	✓
Watts	✓	✓
Workout Summary	✓	✓

* Chest strap required.



Precor Incorporated
20031 142nd Ave NE
P.O. Box 7202
Woodinville, WA USA 98072-4002

Precor, C, CrossRamp, EFX, M, Move Beyond, and SmartRate are registered trademarks of Precor Incorporated. Crosstrainer, QuickStart, and StretchTrainer are trademarks of Precor Incorporated. Copyright 2006 Precor Incorporated. Specifications subject to change without notice.
www.precor.com

NOTICE:

Precor is widely recognized for its innovative, award winning designs of exercise equipment. Precor aggressively seeks U.S. and foreign patents for both the mechanical construction and the visual aspects of its product design. Any party contemplating the use of Precor's product designs is hereby forewarned that Precor considers the unauthorized appropriation of its proprietary rights to be a very serious matter. Precor will vigorously pursue all unauthorized appropriation of its proprietary rights.

EFX5.23/5.33 48158-104, en
Warranty # 36287-110, en
Registration Card# 45623-102, en
4 May 2006

QUICKSTART™

PRECOR^{USA}
move beyond[®]

CAUTION: Before using the EFX[®], read all these instructions. Failure to do so may result in serious injury.

- Do not allow people unfamiliar with its operation, or children, on or near the treadmill.
- Before beginning any fitness program, see your physician for a thorough physical examination. Seek advice from your physician to learn the target heart rate appropriate for your fitness level.
- Always face the display and use the stationary handrail for balance. Never attempt to turn around on the EFX.
- If you feel pain, faintness, or dizziness, stop exercising immediately.

User ID Keys

Pick one of two user ID keys and store workout preferences with your user number. The next time you exercise, press the appropriate USER key when the Precor banner appears. Your workout preferences are immediately restored. Press QUICKSTART to begin working out.

The Locking Pin on the Roller Arm

The locking pin on the EFX ramp secures the roller arm and prevents it from continuous travel up or down the ramp. To prevent unauthorized use, secure the roller arm with the locking pin after every workout. Pull firmly on the pin to slide it out of the roller arm. A lanyard attaches the locking pin to the ramp. Store the locking pin underneath the ramp once it is removed from the roller arm.

EFX[®] 5.23
EFX[®] 5.33

Workout Tips

- Before and after a workout, gently stretch your lower body and back to help prevent stiffness or soreness.
- At the beginning of a workout, take several minutes to bring your heart rate into your target zone (shown in Diagram D on the other side of this card).
- Depending on your level of fitness, consider maintaining a pedaling speed between 100 and 150 strides per minute. Do not drop below 20 strides per minute during a workout or you enter pause mode.
- To pause during your workout, stop pedaling. Pause mode has a 10-minute limit.
- Incorporate a cool-down period into your workout to help lower your heart rate and minimize muscle stiffness or soreness.

Begin Your Workout with QUICKSTART

1. Turn ON the EFX, using the I/O power switch at the base of the rear cover. The Precor banner appears in the center display.
2. Remove the locking pin that secures the roller arm.
3. Hold on to the stationary handrail and step on the foot pedals.
4. Begin pedaling.
***Important:** If your unit has moveable handlebars, do not use them until you are comfortable with the movement of the EFX.*
5. Press QUICKSTART. The MANUAL (MANL) Program begins.
Note: To select a different program or choose a user ID (USER 1 or USER 2), refer to your owner's manual.
6. Use the RESISTANCE ▲▼ or CROSSRAMP ▲▼ keys to change the resistance and ramp incline (EFX5.23).
7. Enter a cool-down period by lowering the strides per minute, the resistance, or the ramp incline (EFX5.23).
8. To review your workout summary, press RESET. The display shows your cumulative time, strides, and the number of calories burned during your workout.
9. When you are done reviewing your workout summary, press RESET to return to the banner.
10. Stop pedaling and hold on to the stationary handrail while you carefully step down from the EFX.
11. To prevent unauthorized use, turn OFF the EFX and secure the roller arm with the locking pin.

Choose a Program

- Determine your level of fitness: beginner, intermediate, or advanced.
- Determine your immediate goal: endurance training, cardio-conditioning, or weight loss.

If you are a beginner, start a cardio-conditioning program to slowly adjust your body to a comfortable level of exercise. Over a recommended 8-week period, you will increase your endurance and strength while improving flexibility.

If you have been exercising and feel that you have reached an intermediate or advanced fitness level, you probably have established goals for yourself.

For all fitness levels, plan to exercise at a comfortable pace for 20 to 30 minutes a day. Wear a chest strap to monitor your heart rate. Supplement your plans with fitness workouts from the Precor website (www.precor.com). The Precor website provides numerous fitness workouts and expert advice to help you reach your fitness goals.

Wear a Chest Strap

During a workout, the heart rate features appear on the display when you wear a chest strap. To receive an accurate reading, the strap needs to be in direct contact with your skin. Be sure to wear the chest strap underneath your clothing.

Note: The Precor heart rate receiver must be properly installed in the display console before a heartbeat can be detected. Check with your dealer to make sure it is installed in your product.

1. Carefully dampen the back of the strap with tap water (Diagram A).

Important: Do not use deionized water. It does not have the proper minerals and salts to conduct electrical impulses.

2. Adjust the strap and fasten it around your chest. The strap should feel snug, not restrictive (Diagram B).
3. Make sure that the chest strap is right side up, lies horizontally across your chest, and is centered in the middle of your chest (Diagram C).



Diagram A

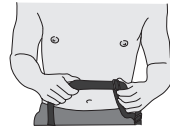

Diagram B

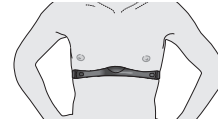

Diagram C

When these steps are complete, you are ready to view your heart rate!

SmartRate® and Heart Rate Features

The SmartRate and heart rate displays provide visual cues that help you adjust your fitness routine to reach your goals. Use these features to keep your heart rate within the target zones for weight loss or cardio-conditioning.

When you begin a workout, a blinking segment in the SmartRate display appears if you entered your age during the setup phase. The blinking segment indicates the current zone of your heart rate: weight loss or cardiovascular. For the ideal weight loss range, your heart rate should remain between 55% and 70% of your maximum aerobic heart rate. To improve your overall cardiovascular and respiratory fitness level, maintain your heart rate between 70% and 85% of your maximum aerobic heart rate.

For the greatest benefits, maintain your heart rate in either zone (weight loss or cardiovascular) for 30 minutes or more at least three times a week.

CAUTION: Your heart rate should never exceed 85% of your maximum aerobic heart rate or go above your target zone (Diagram D).

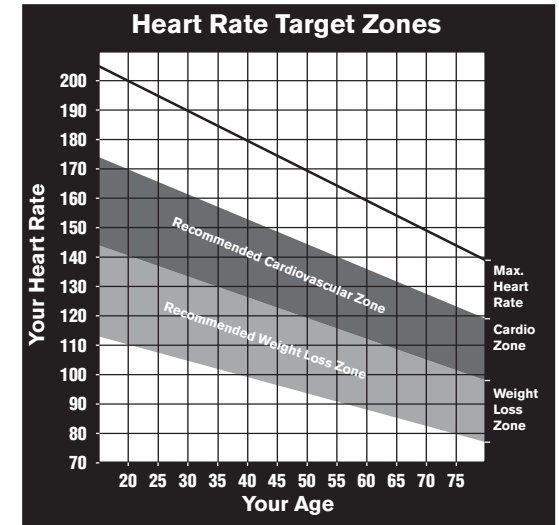

Diagram D

Cool Down After Your Workout

Cooling down is an important aspect of your workout because it helps reduce muscle stiffness and soreness by transporting excess lactic acid out of the working muscles. Cooling down for at least three minutes helps provide a smooth transition that allows your heart rate to return to its normal, non-exercising state.

Assembly Guide



PRECOR[®] USA
move beyond[®]

EFX[®] 5.33
Elliptical Fitness Crosstrainer[™]

Thank you for choosing Precor. For proper installation, please read this guide thoroughly and follow the assembly instructions. If you do not assemble the EFX according to these guidelines, you could void the Precor Limited Warranty.

Obtaining Service

You should not attempt to service the EFX except for maintenance tasks described in the owner's manual. Should you need more information regarding Customer Support numbers or a list of Precor authorized Service Centers, visit the Precor website at www.precor.com.

Unpacking the Equipment

The EFX is carefully tested and inspected before shipment. The unit is shipped in one box. Ask for help from two or more people to unpack and assemble the EFX.

Required Tools







- Wire tie cutter
- Phillips-head screwdriver
- Two $\frac{9}{16}$ -inch wrenches (crescent and combination)
- SAE Standard socket set with socket extension

Installation Requirements

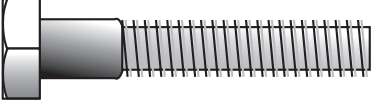
Follow these installation requirements when assembling the unit:

- **Assemble the unit near the location where you plan to use it.**
- **Provide ample space around the unit.**
Open space around the unit allows for easier access.
- **Set up the unit on a solid, flat surface.**
A smooth, flat surface under the unit helps keep it level. A level unit has fewer malfunctions.
- **Open the box and assemble the components in the sequence presented in this guide.**
- **Leave room for adjustments.**
Tighten fasteners (bolts, nuts, and screws), so the unit is stable, but leave room for adjustments. Do not fully tighten fasteners until instructed to do so.

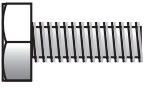
Hardware Kit (not shown to scale)

Fasteners		Quantity
	(A) Phillips-head screw (1/2-inch)	4
	(B) Hex head bolt (2-inch x 3/8-inch)	2
	(C) Washer (3/8-inch x 1.00 OD)	6
	(D) Hex head screw (1-inch x 3/8-inch)	18
	(E) Washer (3/8-inch) x .812 OD)	18
	(F) Hex head screw (1-inch x 5/16-inch)	6
	(G) Washer (5/16-inch)	6
	(H) Locknut (3/8-inch)	2

1 – Height adjuster with hex nut

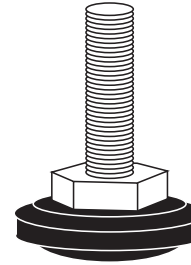

1 – Power cord

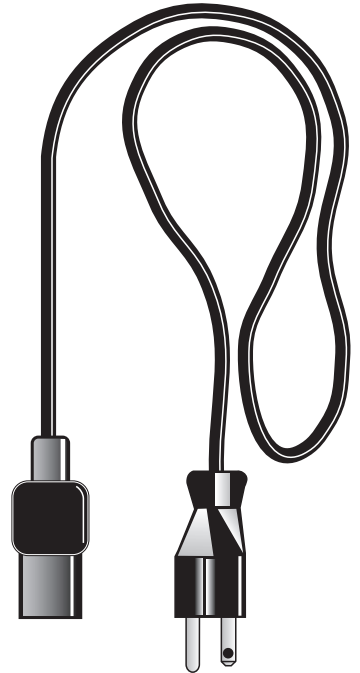

2 – Bushings



4 – Plastic caps

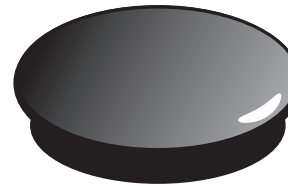

1 – End cap



Assembly Steps

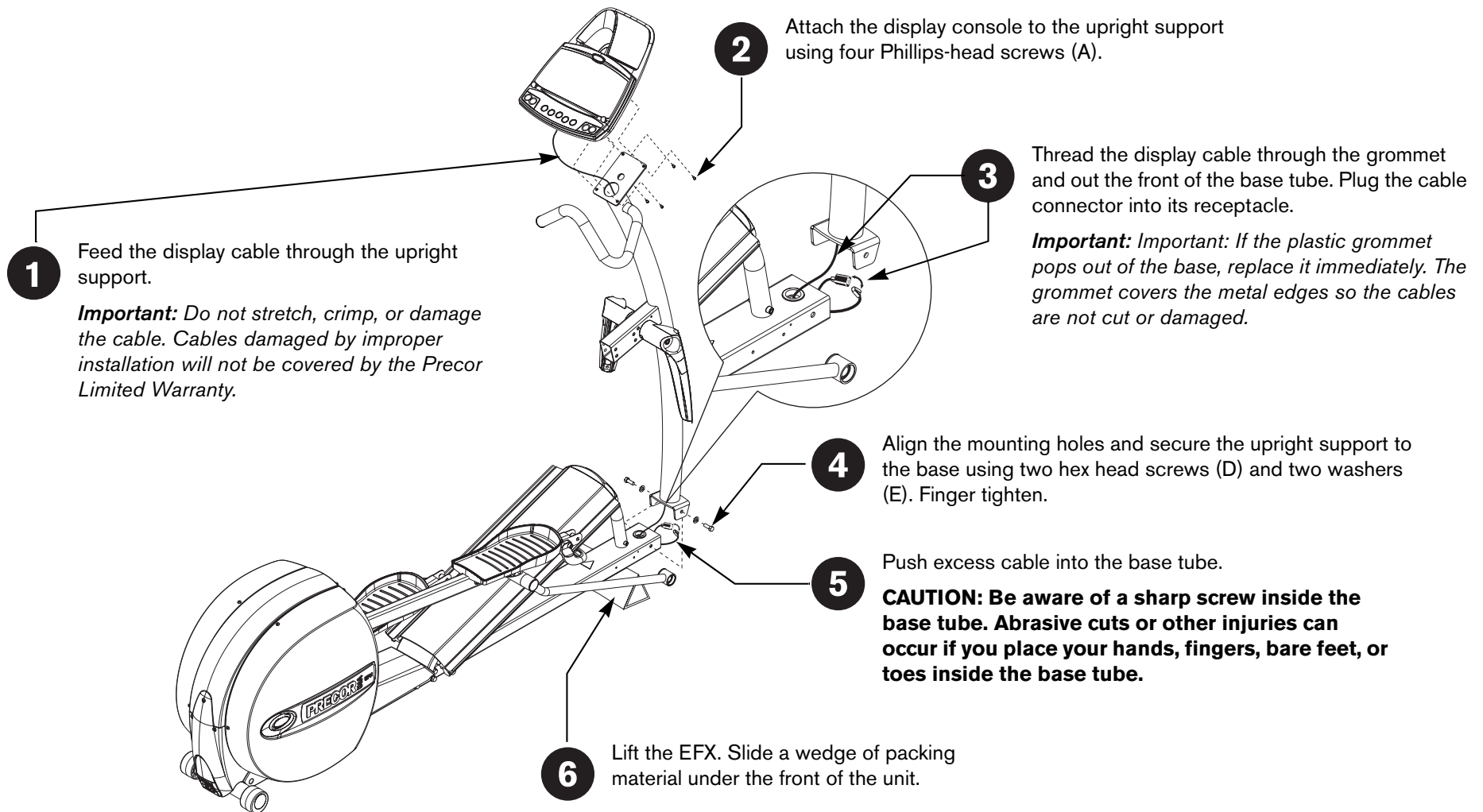

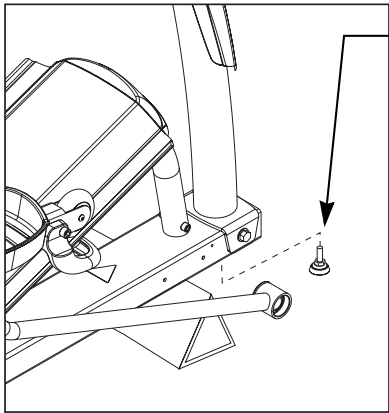

7 Thread the hex nut and height adjuster into the base. Wrench tighten the nut.

8 Attach both stabilizers to the upright support bracket using eight hex head screws (D) and eight washers (E). Finger tighten.

9 Attach the lower portion of both stabilizers to the base frame using eight hex head screws (D) and eight washers (E). Wrench tighten.

10 Return to the upright support bracket. Wrench tighten the eight screws that secure the stabilizers to the bracket.

11 Secure the upright support. Wrench tighten the two screws holding the upright support onto the base.

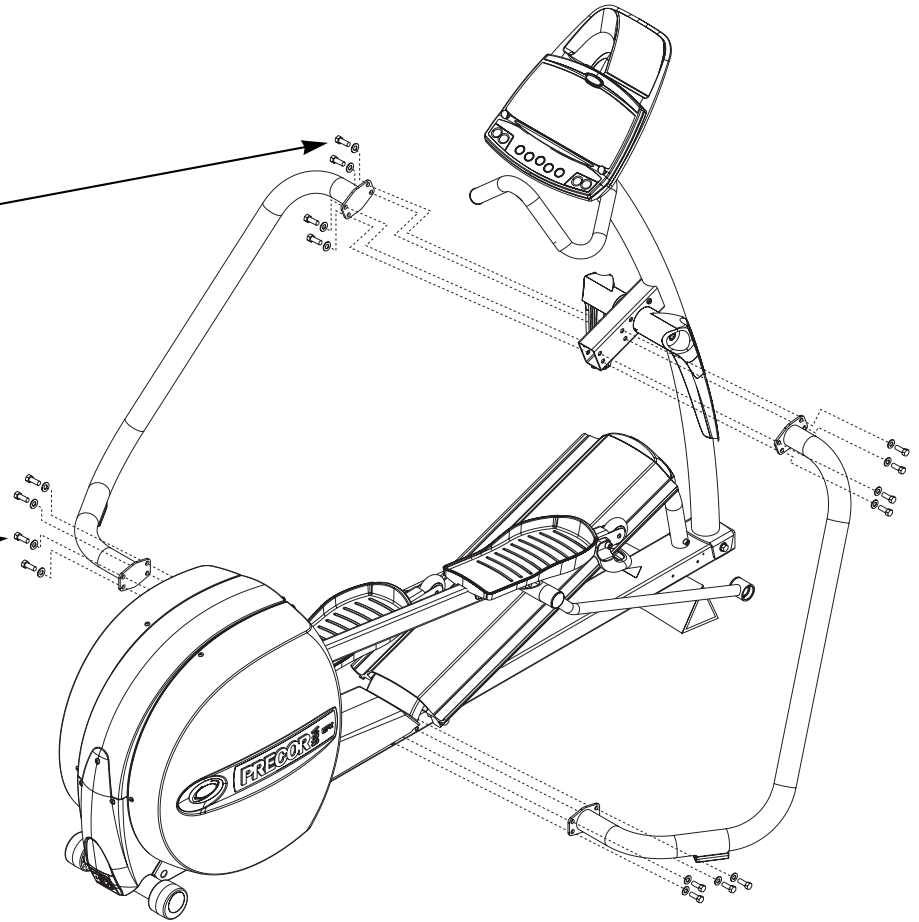

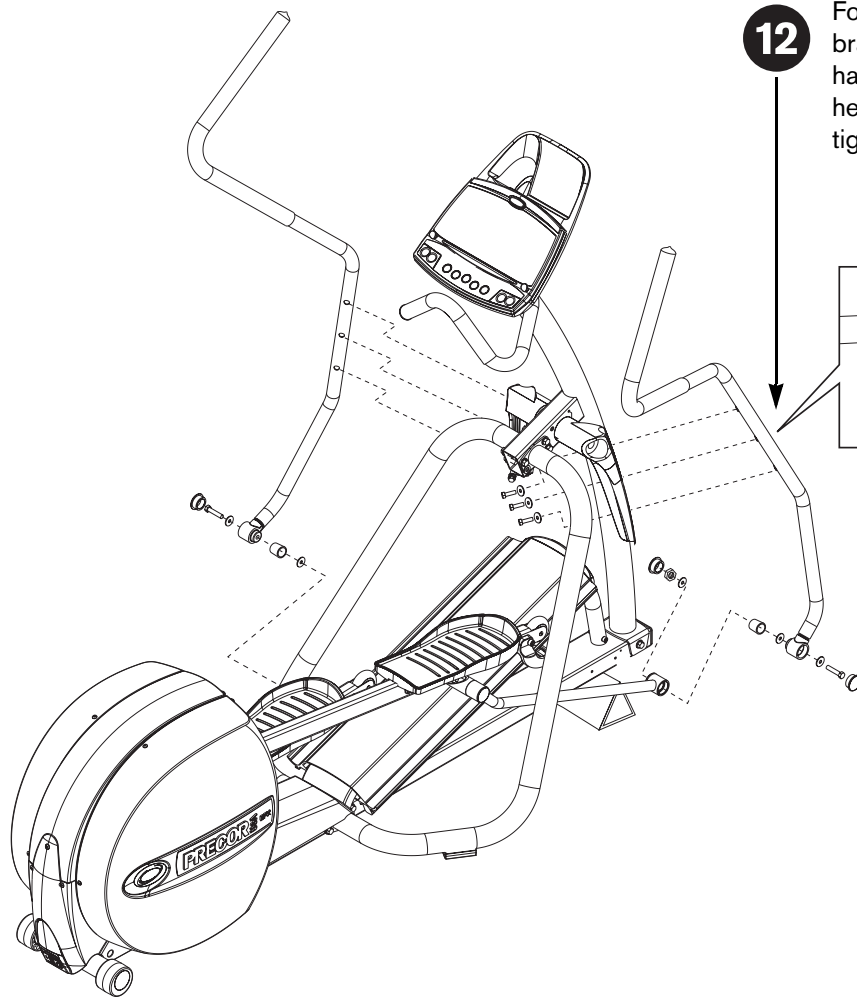

12

For ease of installation, rotate the handlebar bracket to a horizontal position. Insert the handlebars into the handlebar brackets using six hex head screws (F) and six washers (G). Wrench tighten using a 1/2-inch socket wrench.

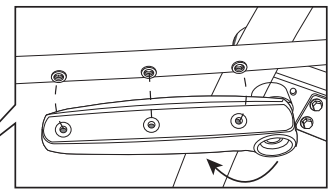

Important: The handlebar mounting holes protrude slightly. Align the protrusions inside the handlebar brackets.

13

For ease of installation, slide the foot pedal to the top of the ramp and attach the handlebars to the pivot arms. Use two hex head bolts (B), six washers (C), two bushings, two locknuts (H), and four plastic caps. Wrench tighten the fasteners before inserting plastic caps.

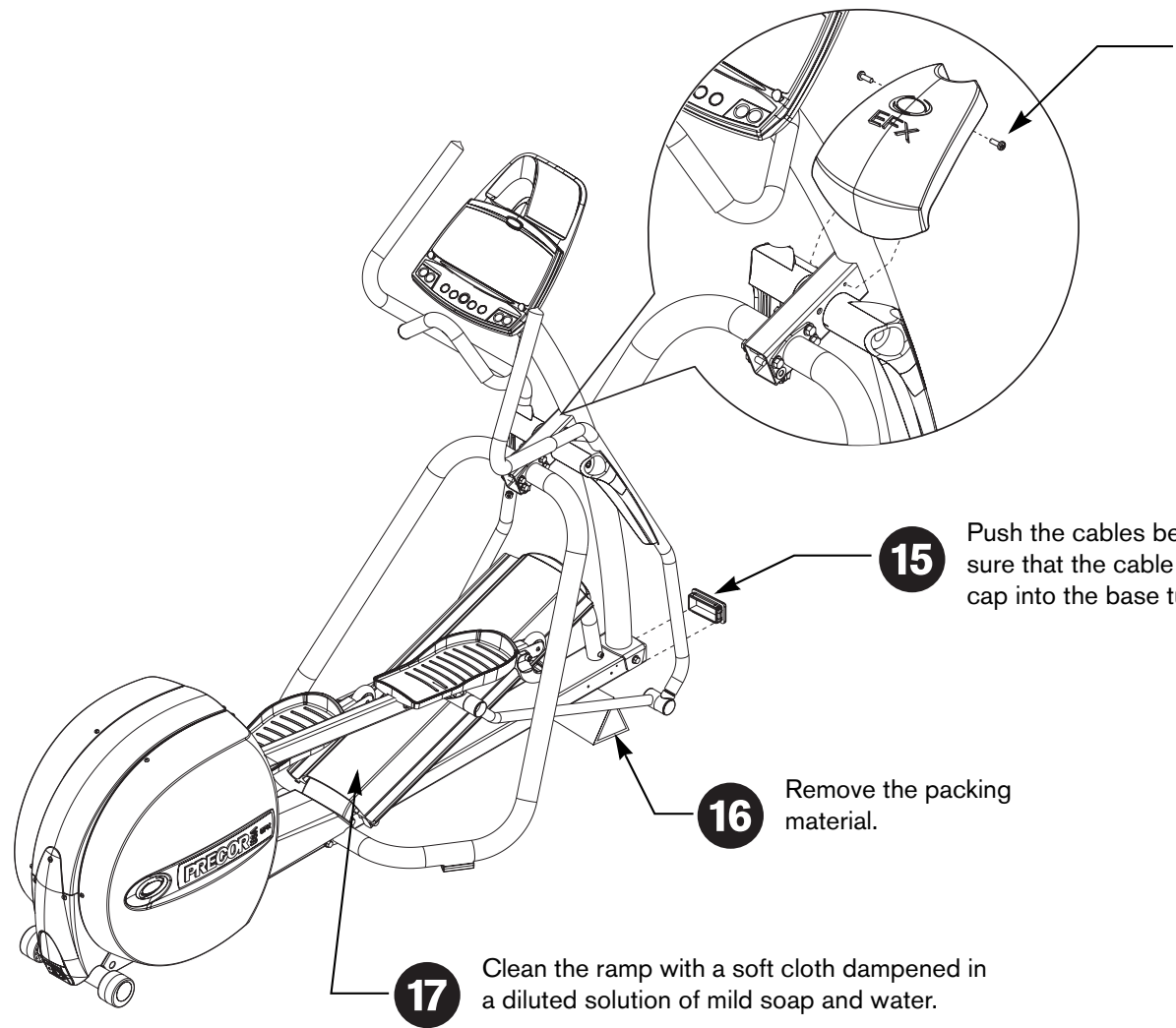

14 Remove two Phillips-head screws from the upright support bracket. Align the bracket cover with the mounting holes. Reinstall the screws and tighten securely.

15 Push the cables behind the height adjuster threads. Make sure that the cable connections are intact. Press the end cap into the base tube.

16 Remove the packing material.

17 Clean the ramp with a soft cloth dampened in a diluted solution of mild soap and water.

18

Level the EFX.

Before exercising, make sure the EFX does not wobble from side to side or front to back. Ask a capable person for help to make adjustments.

Important: *If the unit is placed on a slightly uneven surface, adjusting the rear pads can help, but will not compensate for extremely uneven surfaces.*

1. To remove any side-to-side movement, rotate the rear pads.
2. To counteract any front-to-back rocking motion, ask your assistant to grasp the upper handrails and raise the front of the unit off the floor. Use a crescent or combination wrench to loosen the nut on the height adjuster.

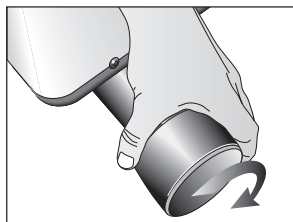

3. Turn the height adjuster to eliminate the rocking motion.

Once you have the proper height adjustment, use the wrench to turn the nut and tighten it securely against the base tube.

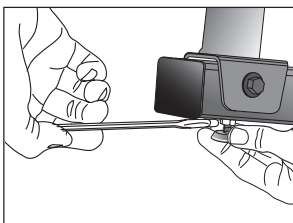

Important: *If, after performing the steps above, the unit still rocks slightly from front to back, you may need to remove the nut on the height adjuster.*

4. Have your assistant carefully lower the unit to the floor.

19

Connect the power cord.

CAUTION: Use the supplied power cord. Do not remove or otherwise bypass the 3-prong plug with an adapter in order to use a non-grounded outlet. Do not plug the EFX into a power transformer in an attempt to adjust the voltage requirements. Failure to follow these instructions might damage the unit and void the Precor Limited Warranty.

1. Insert the power plug connector into its receptacle at the rear of the unit.
2. Plug the other end into a grounded outlet. Be sure to use the appropriate voltage. Refer to *Grounding Instructions* in the owner's manual.

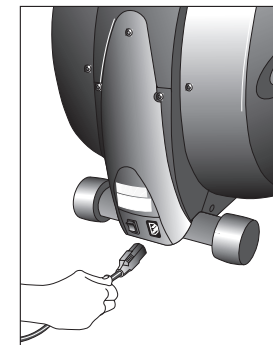
**20**

Turn the unit ON.

Use the ON/OFF (I/O) power switch to turn the unit ON. Check that the Precor banner appears on the display. If the display remains blank, recycle the power, and then check the cable connections.